

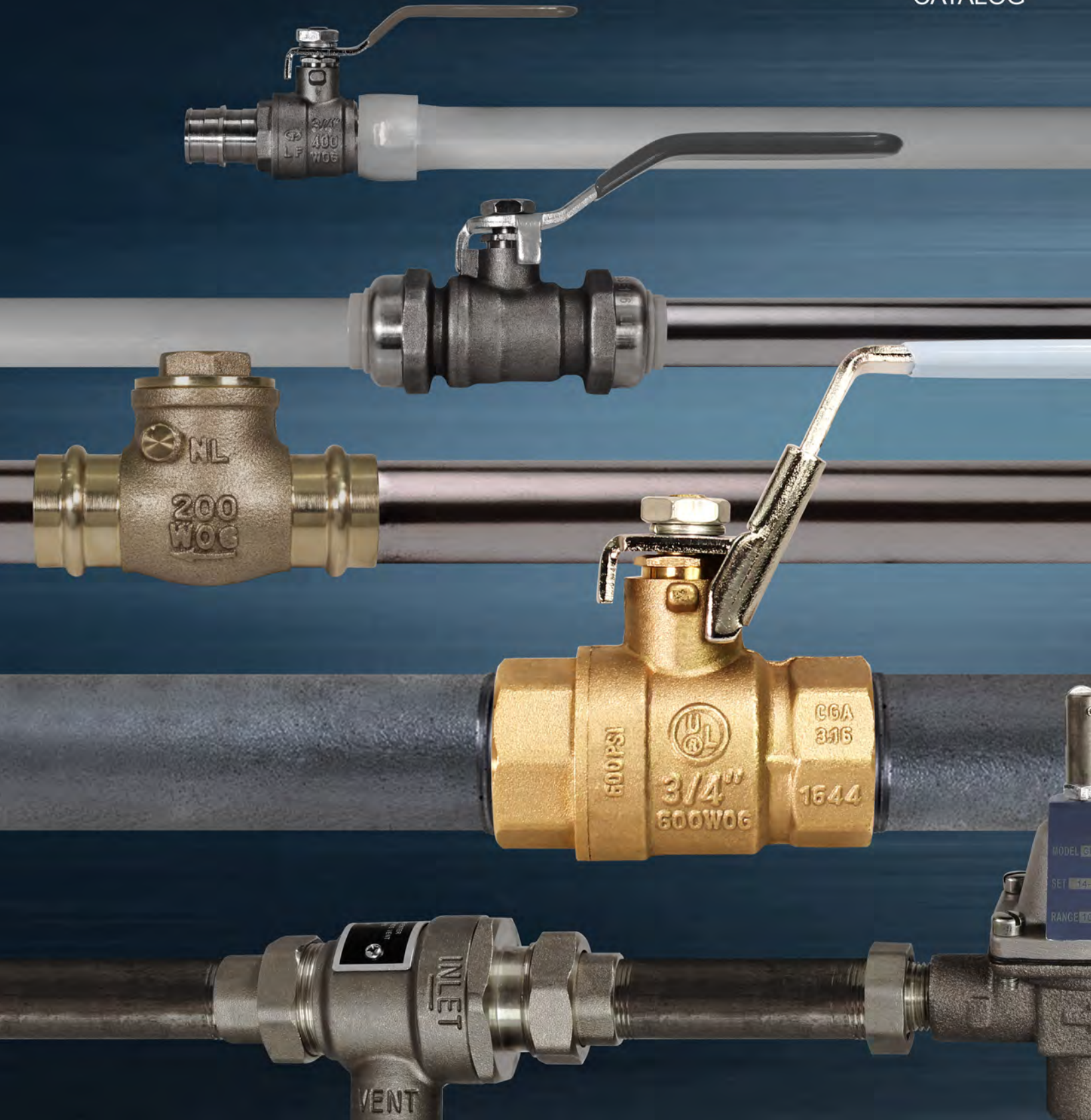

EVERFLOW™

VALVES & HYDRONICS

CATALOG



Trusted Quality. Premium Performance.

For 3 Generations, our team has worked diligently to build strong products with maximum quality, reliability & endurance.

Everflow's New Valve & Hydronics Catalog provides you access to our comprehensive range of valves and related products for commercial and residential applications.

We pride ourselves in providing the finest quality PVF products combined with integrity and dedication to superior customer support. Our national network of distribution centers, allows for increased inventory, shorter shipping times, while providing our customers with the most efficient and cost effective solutions.

Our products meet and exceed national standards, and are approved by many applicable approval agencies.

Our Brands



Our Flagship Brand of Quality Valves & Plumbing Products



Specialty Valves & Hydronic Solutions



Gas Appliance Valves, Connectors & Expansion Tanks



Push to Connect Valves & Fittings



Pex Valves, Fittings & Accessories

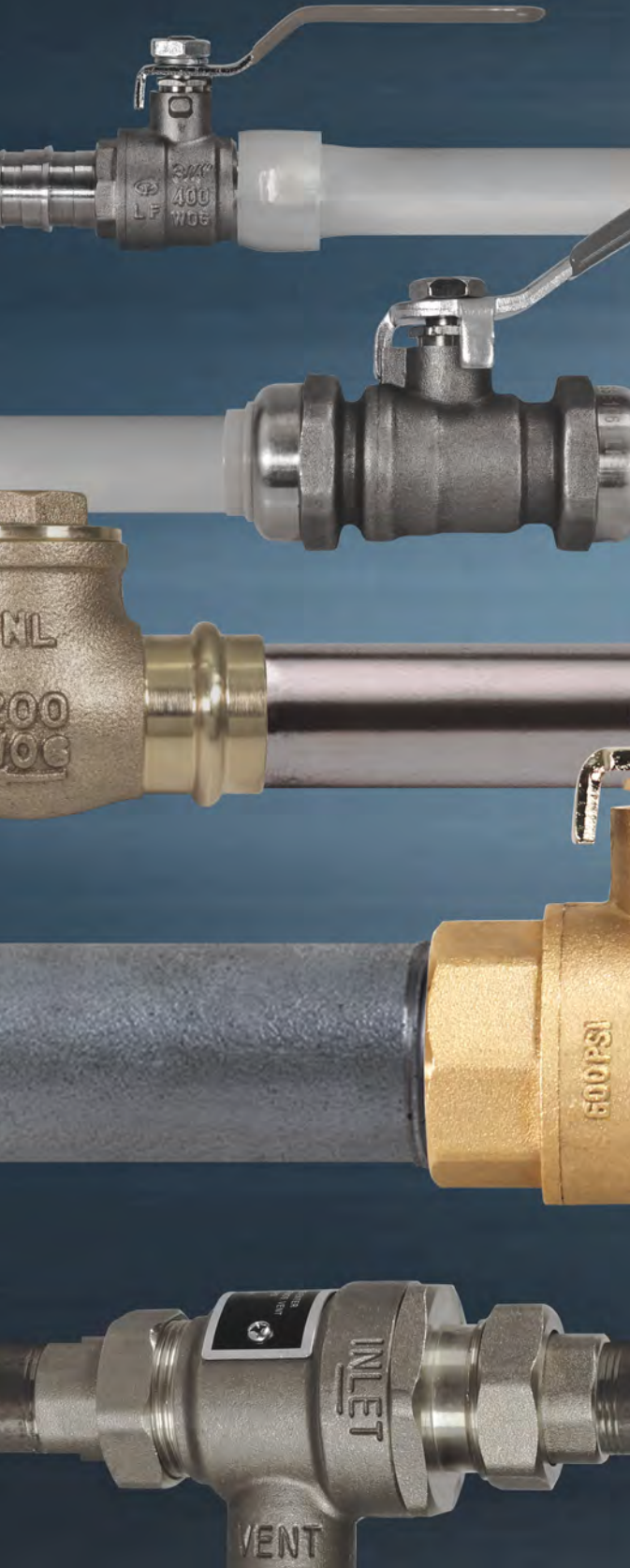

Table of Contents

BALL VALVES

Threaded/Sweat Ball Valves	Pg. 4-12
Gas Ball Valves	Pg. 14-15
Press Ball Valves	Pg. 16-20
Compression Ball Valves	Pg. 13
Push Fit Ball Valves	Pg. 21
Pex F1807 Ball Valves	Pg. 22-26
Pex F1960 Ball Valves	Pg. 26-29
Mini Ball Valves	Pg. 34

SPECIALTY BALL VALVES

Hose Ball Valves	Pg. 11
Flanged Ball Valves	Pg. 30-31
Tankless water Heater Valves	Pg. 32
Hi-Flow 3-Way Drain Valves	Pg. 33
Purge Station Valves	Pg. 35
Expansion Tank Valves	Pg. 34
OP45 One Piece Gas Ball Valve	Pg. 15
Gas Ball Valve w/Screwdriver Slot	Pg. 10

CHECK VALVES

Swing Check Valves	Pg. 36
Press Swing Check Valves	Pg. 36
Inline Swing Check Valves	Pg. 37
Press Swing Check Valves	Pg. 37
Y-Strainer	Pg. 37

GATE VALVES

Brass Gate Valves	Pg. 38
Heavy Duty Brass Gate Valves	Pg. 39
Long Bonnet Gate Valves	Pg. 40-41

COMPRESSION STOP VALVES

Straight Short Globe Valves	Pg. 40
Angle Short Globe Valves	Pg. 41
Stop and Waste Valves	Pg. 40-41
Long Bonnet Stop Valves	Pg. 41

THERMOPLASTIC VALVES

PVC Valves	Pg. 50-53
PVC Specialty Fittings	Pg. 54-55

DRAIN VALVES & SILLCOCKS

Boiler Drains	Pg. 42-43
Hose Bibs	Pg. 44
Sillcocks	Pg. 44-45
Frost Free Sillcocks	Pg. 46-48
Sillcock Replacement Parts	Pg. 46-48

HYDRONIC HEATING & COMPONENTS

Feed Pressure Water Regulator	Pg. 73
Backflow Preventer	Pg. 73
Heating Boiler Air Scoop	Pg. 73
Automatic Air Vent	Pg. 73
Spiral Air Vent	Pg. 74
Thermal & Hydronic Tanks	Pg. 75
Pex Manifolds & Accessories	Pg. 83
Steel Manifolds	Pg. 84
Copper Manifolds	Pg. 85
Radiator Valves	Pg. 76-77
Union Elbow	Pg. 78
Monoflow Tees	Pg. 78
Radiator Valve Tools & Parts	Pg. 79
Thermometers & Gauges	Pg. 68-71

WATER SUPPLY

Press Stops	Pg. 56-57
Multi Turn Stops	Pg. 58
Quarter Turn Stops	Pg. 59-62
Push-Fit Stops	Pg. 62
Washing Machine Valve	Pg. 63
Ice Maker Valve	Pg. 63
Dishwasher Valve	Pg. 63
Anti-Sweat Valve	Pg. 63

SPECIALTY FITTINGS & ACCESSORIES

Compression Couplings	Pg. 13
Dielectric Unions & Nipples	Pg. 66
CPVC Transition Fittings	Pg. 65
Water Meter Couplings	Pg. 64
Meter Bars	Pg. 67
Safety Signs	Pg. 86



Built to Perform.





610 Series Premium Ball Valve

UL Listed • FM & CSA Certified • Lead Free • Full Port • 600 WOG

The 610 Series Premium Ball Valves are used in commercial, industrial and residential applications for a full range of liquids and gases. The body is constructed of durable lead free DZR brass material. The valve features a bottom-loaded blowout-out stem. Stainless steel ball and PTFE seats create a positive seal, reducing friction and minimizing wear.



- Available in 1/4" - 4" Threaded & Sweat
- UL Listed 842,125 psig
- FM Certified FM1140 600 psig 1/4" - 2" IPS, 1/2" - 2" SWT
- CSA Certified 1/2 psig / 5 psig / 125 psig 1/4" - 4"
- Lead Free
- Temperature Range: -20°F to 300°F
- Threaded end connections comply with ANSI/ASME B1.20.1
- Solder end connections comply with ANSI/ASME B16.18

610 SERIES SPECIFICATIONS

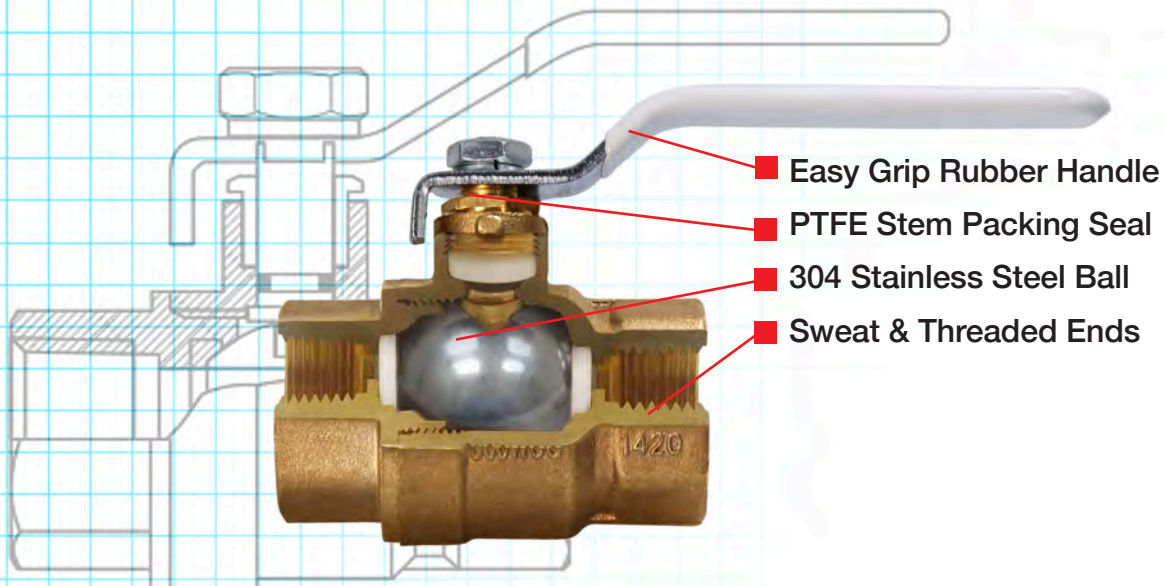

- Easy Grip Rubber Handle
- PTFE Stem Packing Seal
- 304 Stainless Steel Ball
- Sweat & Threaded Ends



BALL VALVES



605 Series Premium Brass Ball Valve

CSA Certified • Lead Free • Full Port • 600 WOG



- Dezincification Resistant (DZR) Lead Free Brass Material
- Stainless Steel Ball 1-1/4" - 2", Chrome Plated Ball 1/2" - 1"
- PTFE Stem Packing Seal and Seats
- Blow Out Proof Stem
- Ends Conform to ANSI B1.20.1 / ASME B16.22
- CSA Certified Threaded 1/4" - 2"
- Conforms to NSF/ANSI-61, NSF/ANSI-372, IGC-157
- 600 psi WOG 150 psi WSP
- Temperature Range: -20°F to 300°F
- ISO:9001 Approved Manufacturer



THREADED PART #	SWEAT PART #	SIZE	DESCRIPTION	INNER	MASTER
605T012-NL	605C012-NL	1/2"	Full Port Ball Valve	10	100
605T034-NL	605C034-NL	3/4"	Full Port Ball Valve	10	100
605T001-NL	605C001-NL	1"	Full Port Ball Valve	5	50
605T114-NL	605C114-NL	1-1/4"	Full Port Ball Valve	5	25
605T112-NL	605C112-NL	1-1/2"	Full Port Ball Valve	5	25
605T002-NL	605C002-NL	2"	Full Port Ball Valve	2	12
605T212-NL	605C212-NL	2-1/2"	Full Port Ball Valve	2	8
605T003-NL	605C003-NL	3"	Full Port Ball Valve	2	6
605T004-NL	605C004-NL	4"	Full Port Ball Valve	2	4

610 Series Premium Brass Ball Valve

UL Listed • FM & CSA Certified • Lead Free • Full Port • 600 WOG



- Dezincification Resistant (DZR) Lead Free Brass Material
- Stainless Steel Ball
- PTFE Stem Packing Seal and Seats
- Blow Out Proof Stem Design
- Ends Conform to ANSI B1.20.1 / ASME B16.22
- Conforms to NSF/ANSI-61, NSF/ANSI-372, IGC-157
- UL Listed 842,125 125 psig
- FM Certified FM1140 600 psig 1/4" - 2" IPS, 1/2" - 2" SWT
- CSA Certified 1/2 psig / 5 psig / 125 psig 1/4" - 4"
- 600 psi WOG 150 psi WSP
- Temperature Range: -20°F to 300°F
- ISO:9001 Approved Manufacturer



THREADED PART #	SWEAT PART #	SIZE	DESCRIPTION	INNER	MASTER
610T014-NL	-	1/4"	Full Port Ball Valve	12	144
610T038-NL	-	3/8"	Full Port Ball Valve	12	144
610T012-NL	610C012-NL	1/2"	Full Port Ball Valve	10	100
610T034-NL	610C034-NL	3/4"	Full Port Ball Valve	10	100
610T001-NL	610C001-NL	1"	Full Port Ball Valve	5	50
610T114-NL	610C114-NL	1-1/4"	Full Port Ball Valve	12	24
610T112-NL	610C112-NL	1-1/2"	Full Port Ball Valve	5	25
610T002-NL	610C002-NL	2"	Full Port Ball Valve	2	12
610T212-NL	610C212-NL	2-1/2"	Full Port Ball Valve	3	6
610T003-NL	610C003-NL	3"	Full Port Ball Valve	2	6
610T004-NL	610C004-NL	4"	Full Port Ball Valve	2	4

BALL VALVES



800 Series High-Grade Ball Valve

Stainless Steel Handle • FM & CSA Certified • Lead Free • Full Port • 600 WOG



- Dezincification Resistant (DZR) Lead Free Brass Material
- Stainless Steel Ball
- PTFE Stem Packing Seal and Seats
- Blow Out Proof Bottom Loaded Stem
- Vinyl Grip Lever Handle
- Stainless Steel Handle
- Ends Conform to ANSI B1.20.1 / ASME B16.22
- Conforms to NSF/ANSI-61, NSF/ANSI-372, IGC-157
- UL Listed/FM Certified Threaded
- CSA Certified Threaded
- 600 psi WOG 150 psi WSP
- Temperature Max: 400°F
- ISO:9001 Approved Manufacturer



THREADED PART #	SWEAT PART #	SIZE	DESCRIPTION	INNER	MASTER
800T014-NL	800C014-NL	1/4"	Full Port Ball Valve	12	144
800T038-NL	800C038-NL	3/8"	Full Port Ball Valve	12	144
800T012-NL	800C012-NL	1/2"	Full Port Ball Valve	10	100
800T034-NL	800C034-NL	3/4"	Full Port Ball Valve	10	100
800T001-NL	800C001-NL	1"	Full Port Ball Valve	5	50
800T114-NL	800C114-NL	1-1/4"	Full Port Ball Valve	12	24
800T112-NL	800C112-NL	1-1/2"	Full Port Ball Valve	5	25
800T002-NL	800C002-NL	2"	Full Port Ball Valve	2	12
800T212-NL	800C212-NL	2-1/2"	Full Port Ball Valve	3	6
800T003-NL	800C003-NL	3"	Full Port Ball Valve	2	6
800T004-NL	800C004-NL	4"	Full Port Ball Valve	2	4

615 Series Lead Free T-Handle Brass Ball Valve



CSA Certified • Lead Free • T-Handle with Vinyl Grip • Full Port • 600 WOG



- Dezincification Resistant (DZR) Lead Free Brass Material
- Forged Brass Body
- Blow Out Proof Stem Design
- Packing Nut & Packing On The Stem Seal
- Stainless Steel Ball
- Vinyl Grip T-Handle
- Ends Conform to ANSI B1.20.1 / ASME B16.22
- CSA Certified to: NSF/ANSI-61, NSF/ANSI-372, IGC-157
- 600 psi WOG 150 psi WSP
- Temperature Range: -20°F to 300°F
- ISO:9001 Approved Manufacturer



THREADED PART #	SWEAT PART #	SIZE	DESCRIPTION	INNER	MASTER
615T014-NL	-	1/4"	Full Port Ball Valve	10	100
615T012-NL	615C012-NL	1/2"	Full Port Ball Valve	10	100
615T034-NL	615C034-NL	3/4"	Full Port Ball Valve	10	100
615T001-NL	615C001-NL	1"	Full Port Ball Valve	5	50

BALL VALVES

L-610 Series Premium Lock Handle Ball Valve

RAVEN
SPECIALTY PRODUCTS

UL Listed • FM & CSA Certified • Lead Free • Full Port • 600 WOG



- Dezincification Resistant (DZR) Lead Free Brass Material
- Latch Lock Handle with Vinyl Grip
- Forged Brass Body
- Stainless Steel Ball
- PTFE Stem Packing Seal and Seats
- Blow Out Proof Stem Design
- Ends Conform to ANSI B1.20.1 / ASME B16.22
- Conforms to NSF/ANSI-61, NSF/ANSI-372, IGC-157
- UL Listed 842,125 125 psig
- FM Certified FM1140 600 psig 1/4" - 2" IPS, 1/2" - 2" SWT
- CSA Certified 1/2 psig / 5 psig / 125 psig 1/4" - 4"
- 600 psi WOG 150 psi WSP
- Temperature Range: -20°F to 300°F
- ISO:9001 Approved Manufacturer



THREADED PART #	SWEAT PART #	SIZE	DESCRIPTION	INNER	MASTER
L-610T012-NL	L-610C012-NL	1/2"	Lock Handle Ball Valve	10	100
L-610T034-NL	L-610C034-NL	3/4"	Lock Handle Ball Valve	10	100
L-610T001-NL	L-610C001-NL	1"	Lock Handle Ball Valve	5	50
L-610T114-NL	L-610C114-NL	1-1/4"	Lock Handle Ball Valve	5	25
L-610T112-NL	L-610C112-NL	1-1/2"	Lock Handle Ball Valve	5	25
L-610T002-NL	L-610C002-NL	2"	Lock Handle Ball Valve	2	12
L-610T212-NL	L-610C212-NL	2-1/2"	Lock Handle Ball Valve	2	8
L-610T003-NL	L-610C003-NL	3"	Lock Handle Ball Valve	2	6
L-610T004-NL	L-610C004-NL	4"	Lock Handle Ball Valve	2	4

405 Series Lead Free Brass Ball Valve with Drain



Purge Drain • CSA Certified • Lead Free • Full Port • 600 WOG



- Dezincification Resistant (DZR) Lead Free Brass Material
- Brass Drain Cap with EPDM Washer
- Forged Brass Body
- Stainless Steel Ball
- PTFE Seats and Seals
- Blow Out Proof Stem
- Ends Conform to ANSI B1.20.1 / ASME B16.22
- Conforms to NSF/ANSI-61/372, IGC-157
- 600 psi WOG 150 psi WSP Service
- Temperature Range: -20°F to 300°F
- CSA Certified
- ISO:9001 Approved Manufacturer



THREADED PART #	SWEAT PART #	SIZE	DESCRIPTION	INNER	MASTER
405T012-NL	405C012-NL	1/2"	Ball Valve With Drain	10	100
405T034-NL	405C034-NL	3/4"	Ball Valve With Drain	10	100
405T001-NL	405C001-NL	1"	Ball Valve With Drain	5	50

855 Series High-Grade T-Handle Ball Valve

RAVEN
SPECIALTY PRODUCTS

Stainless Steel T-Handle • FM & CSA Certified • Lead Free • Full Port • 600 WOG



- Dezincification Resistant (DZR) Lead Free Brass Material
- Stainless Steel Ball
- PTFE Stem Packing Seal and Seats
- Blow Out Proof Bottom Loaded Stem
- Vinyl Grip T-Handle
- Stainless Steel Handle
- Ends Conform to ANSI B1.20.1 / ASME B16.22
- Conforms to NSF/ANSI-61, NSF/ANSI-372, IGC-157
- UL Listed/FM Certified
- CSA Certified
- ISO:9001 Approved Manufacturer



THREADED PART #	SWEAT PART #	SIZE	DESCRIPTION	INNER	MASTER
855T012-NL	855C012-NL	1/2"	Full Port Ball Valve	10	100
855T034-NL	855C034-NL	3/4"	Full Port Ball Valve	10	100

825 Series Ball Valve with Drain

RAVEN
SPECIALTY PRODUCTS

Purge Drain • CSA Certified • Lead Free • Full Port • 600 WOG



- Dezincification Resistant (DZR) Lead Free Brass Material
- Brass Drain Cap with EPDM Washer
- Forged Brass Body
- Stainless Steel Ball
- PTFE Seats and Seals
- Blow Out Proof Stem
- Vinyl Grip Lever Handle
- Ends Conform to ANSI B1.20.1 / ASME B16.22
- Conforms to NSF/ANSI-61/372, IGC-157
- 600 psi WOP 150 psi WSP Service
- Temperature Range: -20°F to 300°F
- CSA Certified
- ISO:9001 Approved Manufacturer



THREADED PART #	SWEAT PART #	SIZE	DESCRIPTION	INNER	MASTER
825T012-NL	825C012-NL	1/2"	Full Port Ball Valve	10	100
825T034-NL	825C034-NL	3/4"	Full Port Ball Valve	10	100
825T001-NL	-	1"	Full Port Ball Valve	5	50

BALL VALVES

Screwdriver Slotted Ball Valves



620 Series Ball Valve

Lead Free • Screwdriver Slotted Handle • Cast Brass Body •



- Dezincification Resistant (DZR) Lead Free Brass Material
- Screwdriver Slotted Handle
- Cast Brass Body
- Blow Out Proof Stem Design
- Stainless Steel Ball
- Conforms to NSF/ANSI 372
- Pressure Rating is 400 WOG Non Shock
- Temperature Rating is 250°F



PART #	SIZE	DESCRIPTION	INNER	MASTER
620S012-NL	1/2"	Ball Valve W/Screw Driver Slot	10	100
620S034-NL	3/4"	Ball Valve W/Screw Driver Slot	10	120
620S001-NL	1"	Ball Valve W/Screw Driver Slot	6	60

53 Series Long Bonnet Ball Valve

Lead Free • Standard Port • Forged Brass Body • T-Handle With Vinyl Grip

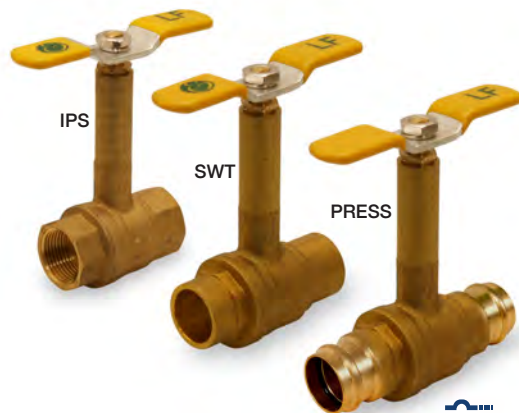

- Long Bonnet T-Handle allows easy shutoff access
- Forged Brass Body
- Chrome Plated Ball
- 175 psi Steam 600 psi WOG
- Temperature Range is -20°C to 120°C
- Press Ends IAMPO Listed



THREADED PART #	SWEAT PART #	SIZE	DESCRIPTION	INNER	MASTER
53122-NL	53121-NL	1/2"	Long Bonnet Ball Valve	10	100
53342-NL	53341-NL	3/4"	Long Bonnet Ball Valve	10	100

Press Long Bonnet Ball Valve

PRESS PART #	SIZE	DESCRIPTION	INNER	MASTER
530R012-NL	1/2"	Press Long Bonnet Ball Valve	10	100
530R034-NL	3/4"	Press Long Bonnet Ball Valve	10	100



BALL VALVES



MIP x FIP Ball Valve

Lead Free • Full Port • 600 WOG



- Dezincification Resistant (DZR) Lead Free Brass Material
- Brass Body
- Blow Out Proof Stem Design
- Packing Nut, O-Ring & PTFE Seal on the Seal
- Stainless Steel Ball
- Vinyl Grip Lever Handle
- Ends Conform to ANSI B1.20.1 / ASME B16.22
- CSA Certified to NSF/ANSI-61, NSF/ANSI-372, IGC-157
- Pressure Rating: 600 psi WOG 150 psi WSP
- Temperature Range -20°F to 300°F
- ISO:9001 Approved Manufacturer



PART #	SIZE	DESCRIPTION	INNER	MASTER
600MF012-NL	1/2"	Full Port Ball Valve	10	100
600MF034-NL	3/4"	Full Port Ball Valve	10	100
600MF001-NL	1"	Full Port Ball Valve	5	50
600MF114-NL	1-1/4"	Full Port Ball Valve	12	24
600MF112-NL	1-1/2"	Full Port Ball Valve	5	25
600MF002-NL	2"	Full Port Ball Valve	2	12

Hose Ball Valve with Cap



Lead Free • Hose Connection • Includes Cap & Chain • Full Port • 600 WOG



- Dezincification Resistant (DZR) Lead Free Brass Material
- Cap and Seal for Easy Drain and Hose Connection
- Brass Body
- Blow Out Proof Stem Design
- Packing Nut, O-Ring & PTFE Seal on the Seal
- Stainless Steel Ball
- Vinyl Grip Lever Handle
- Ends Certified to ANSI B1.20.1 / ASME B16.22
- Press Ends conform to ANSI Z1157
- CSA Certified to NSF/ANSI-61, NSF/ANSI-372, IGC-157
- Pressure Rating: 600 psi WOG 150 psi WSP
- Temperature Range -20°F to 300°F
- ISO:9001 Approved Manufacturer



THREADED PART #	SWEAT PART #	SIZE	DESCRIPTION	INNER	MASTER
THBV-012-NL	CHBV-012-NL	1/2"	Full Port Ball Valve	10	100
THBV-034-NL	CHBV-034-NL	3/4"	Full Port Ball Valve	10	100

Press x Hose Ball Valve with Cap



PRESS PART #	SIZE	DESCRIPTION	INNER	MASTER
RHBV-012-NL	1/2"	Press Ball Valve	10	100
RHBV-034-NL	3/4"	Press Ball Valve	10	100

BALL VALVES & ACCESSORIES



300 Series Premium Gas Ball Valve

UL/FM & CSA Certified • Full Port • For Gas and Non Potable Water Use • 600 WOG



- Forged Brass Body
- Stainless Steel Ball
- PTFE Stem Packing Seal and Seats
- Blow Out Proof Stem Design
- Ends Conform to ANSI B1.20.1 / ASME B16.22
- Conforms to NSF/ANSI-61, NSF/ANSI-372, IGC-157
- UL Listed 842,125 125 psig
- FM Certified FM1140 600 psig 1/4" - 2" IPS, 1/2" - 2" SWT
- CSA Certified 1/2 psig / 5 psig / 125 psig 1/4" - 4"
- 600 psi WOG 150 psi WSP
- Temperature Range : -20°F to 300°F
- ISO:9001 Approved Manufacturer



THREADED PART #	SWEAT PART #	SIZE	DESCRIPTION	INNER	MASTER
300T012	300C012	1/2"	Full Port Ball Valve	10	100
300T034	300C034	3/4"	Full Port Ball Valve	10	100
300T001	300C001	1"	Full Port Ball Valve	5	50
300T114	300C114	1-1/4"	Full Port Ball Valve	5	25
300T112	300C112	1-1/2"	Full Port Ball Valve	5	25
300T002	300C002	2"	Full Port Ball Valve	2	12
300T212	300C212	2-1/2"	Full Port Ball Valve	2	8
300T003	300C003	3"	Full Port Ball Valve	1	6
300T004	300C004	4"	Full Port Ball Valve	1	4

Ball Valve Stem Extension

Solid Brass • Easily Mounts on Ball Valve



- Easy Installation
- Extends Handle Stem for Easy Shutoff Access

PART #	SIZE	DESCRIPTION	INNER	MASTER
STEX1-NL	1/4" 3/8" 1/2"	Ball Valve Stem Extension	1	100
STEX2-NL	3/4" X 1"	Ball Valve Stem Extension	1	100
STEX3-NL	1-1/4" 1-1/2" 2"	Ball Valve Stem Extension	1	100

Stainless Steel Handle w/ Washer & Nut

Stainless Steel with Vinyl Grip Handle



- Stainless Steel Construction
- Vinyl Grip Lever Handle
- Includes Washer and Nut

PART #	SIZE	DESCRIPTION	INNER	MASTER
610HANSS034	3/4"	Stainless Steel Handle	5	50
610HANSS001	1"	Stainless Steel Handle	5	40
610HANSS114	1-1/4"	Stainless Steel Handle	4	20

COMPRESSION BALL VALVES



600M Series Compression Ball Valve

CSA Certified • Lead Free • Compression Connection • Full Port • Vinyl Grip Handle • 600 WOG



600M001-NL

- Dezincification Resistant (DZR) Lead Free Brass Material
- Compression Connection
- Forged Brass Body
- Stainless Steel Ball
- Blow Out Proof Stem
- CSA Certified Per NSF/ANSI-61, NSF/ANSI-372, IGC-157
- 600 psi WOG 150 psi WSP Service
- Temperature Range : -20°F to 300°F
- ISO:9001 Approved Manufacturer



PART #	SIZE	DESCRIPTION	INNER	MASTER
600M012-NL	1/2"	1/2" Compression Ball Valve	10	100
600M034-NL	3/4"	3/4" Compression Ball Valve	10	100
600M001-NL	1"	1" Compression Ball Valve	5	50

825M Series Compression Ball Valve with Drain



CSA Certified • Lead Free • Compression Connection • Full Port • Vinyl Grip Handle • 600 WOG



825M034-NL

- Dezincification Resistant (DZR) Lead Free Brass Material
- Compression Connection
- Forged Brass Body
- Stainless Steel Ball
- Blow Out Proof Stem
- CSA Certified Per NSF/ANSI-61, NSF/ANSI-372, IGC-157
- 600 psi WOG 150 psi WSP Service
- Temperature Range : -20°F to 300°F



PART #	SIZE	DESCRIPTION	INNER	MASTER
825M012-NL	1/2"	1/2" Compression Ball Valve	10	100
825M034-NL	3/4"	3/4" Compression Ball Valve	10	100
825M001-NL	1"	1" Compression Ball Valve	5	50

Compression Coupling Short

Lead Free • Brass

- Brass Body
- 3" Length - Short Pattern
- Brass Packing Nut



PART #	SIZE	DESCRIPTION	INNER	MASTER
BRCS0012-NL	1/2"	Compression Coupling	10	100
BRCS0034-NL	3/4"	Compression Coupling	12	120
BRCS0100-NL	1"	Compression Coupling	12	96
BRCS0114-NL	1-1/4"	Compression Coupling	12	96
BRCS0112-NL	1-1/2"	Compression Coupling	12	48
BRCS0200-NL	2"	Compression Coupling	1	1

Compression Coupling long

Lead Free • Brass

- Brass Body
- 5" Length - Long Pattern
- Brass Packing Nut



PART #	SIZE	DESCRIPTION	INNER	MASTER
BRCL0012-NL	1/2"	Compression Coupling	24	144
BRCL0034-NL	3/4"	Compression Coupling	12	72
BRCL0100-NL	1"	Compression Coupling	12	48
BRCL0114-NL	1-1/4"	Compression Coupling	12	48
BRCL0112-NL	1-1/2"	Compression Coupling	12	48
BRCL0200-NL	2"	Compression Coupling	12	24

Gas Ball Valves

UL/CSA Approved

Flextron gas ball valves are specially engineered to provide superior performance and reliability. For use with natural, manufactured, mixed liquefied petroleum gases and LP gas-air mixtures.

- Forged Brass Body
- Stainless Steel Ball
- Aluminum Alloy Handle
- Ends Conforms to: ANSI B1.20.1
- 600 psi WOG 175 psi WSP
- Temperature Range : -4° F to 149° F
- CSA Certified: ANSI Z21.15/CSA 9.1(1/2psi)
ASME B16.44 / CR91-002 (5psi)
ASME B16.33 / CGA3.16 (175psi)
- UL Listed per: UL 125 (Guide YSDT) 125 WOG



FIP x FIP Gas Ball Valve



PART #	SIZE	DESCRIPTION	INNER	MASTER
FTGV-38F38F	5/8" x 1/2"	FIP x FIP Gas Ball Valve	10	100
FTGV-12F12F	1/2" x 1/2"	FIP x FIP Gas Ball Valve	10	100
FTGV-34F34F	3/4" x 3/4"	FIP x FIP Gas Ball Valve	5	100
FTGV-01F01F	1" x 1"	FIP x FIP Gas Ball Valve	8	60

Flare x FIP Gas Ball Valve



PART #	SIZE	DESCRIPTION	INNER	MASTER
FTGV-58R12F	5/8" x 1/2"	Flare x FIP Gas Ball Valve	10	120
FTGV-58R34F	5/8" x 3/4"	Flare x FIP Gas Ball Valve	10	120
FTGV-12R12F	1/2" x 1/2"	Flare x FIP Gas Ball Valve	10	120
FTGV-38R12F	3/8" x 1/2"	Flare x FIP Gas Ball Valve	5	50

Angle Gas Ball Valve



PART #	SIZE	DESCRIPTION	INNER	MASTER
FTGV-58R34A	5/8" x 3/4"	Flare x FIP Angle Gas Valve	10	120
FTGV-12R12A	1/2" x 1/2"	Flare x FIP Angle Gas Valve	10	120
FTGV-38R12A	3/8" x 1/2"	Flare x FIP Angle Gas Valve	10	120

Flare x Flare Gas Ball Valve



PART #	SIZE	DESCRIPTION	INNER	MASTER
FTGV-38R38R	3/8" x 3/8"	Flare x Flare Gas Ball Valve	10	120
FTGV-12R12R	1/2" x 1/2"	Flare x Flare Gas Ball Valve	10	120

Lever Handle Gas Ball Valve



- Solder Ends
- Forged Brass Body
- Chrome Plated Ball



PART #	SIZE	DESCRIPTION	INNER	MASTER
FTGV-14F14F	1-1/4" x 1-1/4"	FIP x FIP Gas Valve	12	24
FTGV-15F15F	1-1/2" x 1-1/2"	FIP x FIP Gas Valve	9	18
FTGV-02F02F	2" x 2"	FIP x FIP Gas Valve	6	12

GAS BALL VALVES

45 Series FIP Gas Ball Valve



FIP x FIP • Forged Brass Body



- Forged Brass Body
- Stainless Steel Ball
- Blow Out Proof Brass Stem
- Aluminum Alloy Handle
- Thread Ends Conform to: ANSI B1.20.1
- 600 psi WOG 175 psi WSP
- Temperature Range : -4°F to 149°F
- CSA Certified Per: ANSI Z21.15 / CSA 9.1(1/2psi)
ASME B16.44 / CR91-002 (5psi)
ASME B16.33 / CGA3.16 (175psi)
- UL Listed per: UL 125 (Guide YSDT) 125 WOG



PART #	SIZE	DESCRIPTION	INNER	MASTER
4512	1/2"	Gas Ball Valve	10	120
4534	3/4"	Gas Ball Valve	10	120
4501T	1"	Gas Ball Valve	5	50

45Y Series FIP Gas Ball Valve



FIP x FIP • Forged Brass Body



- Forged Brass Body
- Stainless Steel Ball
- Blow Out Proof Brass Stem
- Aluminum Alloy Yellow Handle
- Thread Ends Conform to: ANSI B1.20.1
- 600 psi WOG 175 psi WSP
- Temperature Range : -4°F to 149°F
- CSA Certified Per: ANSI Z21.15 / CSA 9.1(1/2psi)
ASME B16.44 / CR91-002 (5psi)
ASME B16.33 / CGA3.16 (175psi)
- UL Listed per: UL 125 (Guide YSDT) 125 WOG



PART #	SIZE	DESCRIPTION	INNER	MASTER
4512Y	1/2"	Gas Ball Valve	10	120
4534Y	3/4"	Gas Ball Valve	10	120
4501T	1"	Gas Ball Valve	5	50

OP45 One Piece Gas Ball Valve



CSA Approved • Female NPT x Female NPT • Brass Body



- Brass Body
- Plated Steel Handle
- PTFE Ball Seats
- Blow Out Proof Brass Stem
- Thread Ends Conform ANSI B1.20.1
- Pressure Rating: 125 psi (GAS) Service
- Temperature Range: -4°F to 149°F
- CSA Certified: ANSI Z21.15/CSA 9.1 for 1/2 psig
ASME B16.44/CR91-002 for 5 psig
ASME B16.33/CGA3.16 for 125 psig



PART #	SIZE	DESCRIPTION	INNER	MASTER
OP4512	1/2"	Gas Ball Valve	10	120
OP4534	3/4"	Gas Ball Valve	10	120
OP4501	1"	Gas Ball Valve	5	50

S45 Gas Ball Valve w/Screwdriver Slot



CSA & UL Approved • Female NPT x Female NPT • Brass Body



- Brass Body
- Plated Steel Handle
- PTFE Ball Seats
- Blow Out Proof Brass Stem
- Thread Ends Conform ANSI B1.20.1
- Pressure Rating: 125 psi (GAS) Service
- Temperature Range: -4°F to 149°F
- UL Certified 1/2" - 3/4" 125 psig
- CSA Certified: ANSI Z21.15/CSA 9.1 for 1/2 psig
ASME B16.44/CR91-002 for 5 psig
ASME B16.33/CGA3.16 for 125 psig



PART #	SIZE	DESCRIPTION	INNER	MASTER
S4512	1/2"	Gas Ball Valve	10	120
S4534	3/4"	Gas Ball Valve	10	120
S4501	1"	Gas Ball Valve	5	50



Press Forward.





310R Series Premium Press Ball Valve

Double-O-Ring • Press Ends • Lead Free • 600 WOG

The 310 Series Premium Press Ball Valve is designed to use in press-fit piping systems, eliminating labor and potential fire hazard associated with solder connections. It features Double O-Ring press connections for added leak protection and safety. DZR brass body provides increased durability. Stainless steel ball and PTFE seats creates a positive seal reducing friction and minimizing wear.



- Available 1/2" to 4"
- Pressure Rating: 250 CWP / 150 WSP
- Max Temp: 300°F
- DZR Brass Body
- 304 Stainless Steel Ball
- Lead Free Compliant
- Conforms to NSF/ANSI 61, 372

310R SERIES SPECIFICATIONS

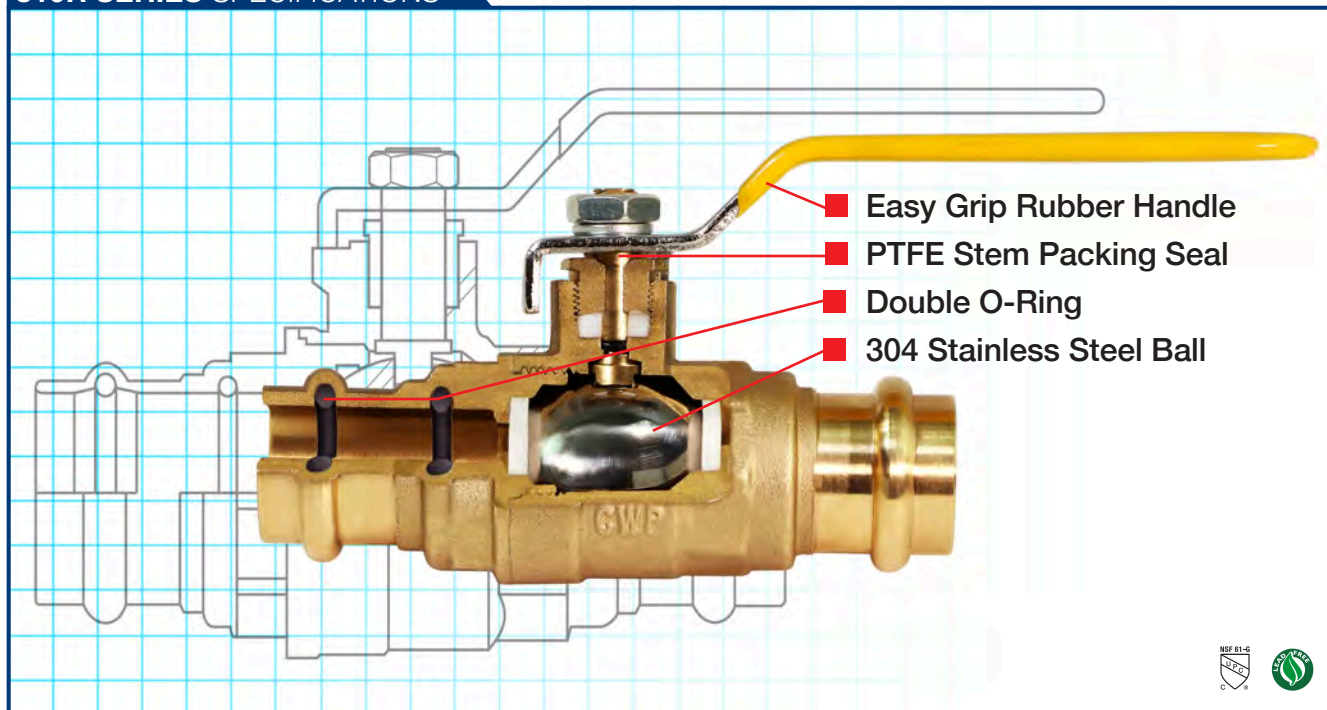

PRESS BALL VALVES



310R Series Premium Press Ball Valve

Double-O-Ring • Press Connections • Lead Free • Full Port • 600 WOG



310R034-NL

- Dezincification Resistant (DZR) Lead Free Brass Material
- Double O-Ring for Added Leak Protection
- Forged Brass Body
- Stainless Steel Ball
- Blow Out Proof Brass Stem
- Vinyl Grip Lever Handle
- Triple Sealing Stem with 2 O-Rings and PTFE Seal
- Max Pressure Rating: 600 psi WOG / 150 psi WSP
- Temperature Range: -20°F to 300°F
- UPC Compliant
- AB1953, NSF61-9, NSF-372, ISO-9002



PART #	SIZE	DESCRIPTION	INNER	MASTER
310R012-NL	1/2"	Full Port Press Ball Valve	5	50
310R034-NL	3/4"	Full Port Press Ball Valve	5	40
310R001-NL	1"	Full Port Press Ball Valve	4	20
310R114-NL	1-1/4"	Full Port Press Ball Valve	5	20
310R112-NL	1-1/2"	Full Port Press Ball Valve	4	16
310R002-NL	2"	Full Port Press Ball Valve	2	8
310R212-NL	2-1/2"	Full Port Press Ball Valve	1	6
310R003-NL	3"	Full Port Press Ball Valve	1	4
310R004-NL	4"	Full Port Press Ball Valve	1	2

810R Series Press Ball Valve



Press Connections • Lead Free • Full Port • 600 WOG



810R003-NL

- Dezincification Resistant (DZR) Lead Free Brass Material
- Forged Brass Body
- Stainless Steel Ball
- Blow Out Proof Brass Stem
- Vinyl Grip Lever Handle
- Triple Sealing Stem with 2 O-Rings and PTFE Seal
- Max Pressure Rating: 600 psi WOG / 150 psi WSP
- Temperature Range: -20°F to 300°F
- UPC Compliant
- AB195, NSF61-9, NSF-372, ISO-9002



PART #	SIZE	DESCRIPTION	INNER	MASTER
810R012-NL	1/2"	Full Port Press Ball Valve	5	50
810R034-NL	3/4"	Full Port Press Ball Valve	5	40
810R001-NL	1"	Full Port Press Ball Valve	4	20
810R114-NL	1-1/4"	Full Port Press Ball Valve	5	20
810R112-NL	1-1/2"	Full Port Press Ball Valve	4	16
810R002-NL	2"	Full Port Press Ball Valve	2	8
810R003-NL	3"	Full Port Press Ball Valve	1	4
810R004-NL	4"	Full Port Press Ball Valve	1	2

PRESS BALL VALVES

310D Series Press Ball Valve with Drain

RAVEN
SPECIALTY PRODUCTS

Press Connections • Lead Free • Full Port with Drain • 250 CWP

PRESS
CONNECT



- Dezincification Resistant (DZR) Lead Free Brass Material
- Blow Out Proof Brass Stem
- Packing Nut, O-ring & Packing on the Stem Seal
- Max Pressure Rating: 250 CWP / 150 WSP
- Temperature Range: -20°F to 300°F
- IAPMO: NSF/ANSI-61, NSF/ANSI-372, IGC-157
- Press Ends Conform to ANSI Z1157



PART #	SIZE	DESCRIPTION	INNER	MASTER
310D012-NL	1/2"	Press Ball Valve with Waste	5	50
310D034-NL	3/4"	Press Ball Valve with Waste	5	40
310D001-NL	1"	Press Ball Valve with Waste	4	20

320 Series Press Adapter Ball Valve

RAVEN
SPECIALTY PRODUCTS

Press x MIP & Press x FIP • Lead Free • Full Port • Forged Brass Body • 250 CWP

PRESS
CONNECT



- Dezincification Resistant (DZR) Lead Free Brass Material
- Blow Out Proof Brass Stem
- Packing Nut, O-Ring & Packing on the Stem Seal
- Max Pressure Rating: 250 CWP / 150 WSP
- Temperature Range: -20°F to 300°F
- Certified to: NSF/ANSI 61, NSF/ANSI 372, IGC157
- Press Ends Conform to ANSI Z1157



320M Series Press x MIP Ball Valve

PART #	SIZE	DESCRIPTION	INNER	MASTER
320M012-NL	1/2"	Press x MIP Ball Valve	5	50
320M034-NL	3/4"	Press x MIP Ball Valve	5	40
320M001-NL	1"	Press x MIP Ball Valve	4	20
320M114-NL	1-1/4"	Press x MIP Ball Valve	5	20
320M112-NL	1-1/2"	Press x MIP Ball Valve	4	16
320M002-NL	2"	Press x MIP Ball Valve	2	8

PRESS
CONNECT



320T Series Press x FIP Ball Valve

PART #	SIZE	DESCRIPTION	INNER	MASTER
320T012-NL	1/2"	Press x FIP Ball Valve	5	50
320T034-NL	3/4"	Press x FIP Ball Valve	5	40
320T001-NL	1"	Press x FIP Ball Valve	4	20
320T114-NL	1-1/4"	Press x FIP Ball Valve	5	20
320T112-NL	1-1/2"	Press x FIP Ball Valve	4	16
320T002-NL	2"	Press x FIP Ball Valve	2	8



Please see the entire line of Press products in our catalog or visit us online at everflowsupplies.com



PRESS BALL VALVES



315R Series Premium Press T-Handle Ball Valve

Double-O-Ring • Press Connections • Lead Free • Full Port • 600 WOG



PRESS
CONNECT



- Dezincification Resistant (DZR) Lead Free Brass Material
- Double O-Ring for Added Leak Protection
- Blow Out Proof Brass Stem
- Triple Sealing Stem with 2 O-Rings and PTFE Seal
- Max Pressure Rating: 600 psi WOG / 150 psi WSP
- Temperature Range: -20°F to 300°F
- UPC Compliant
- AB1953, NSF61-9, NSF-372, ISO-9002



PART #	SIZE	DESCRIPTION	INNER	MASTER
315R012-NL	1/2"	T-Handle Full Port Press Ball Valve	5	50
315R034-NL	3/4"	T-Handle Full Port Press Ball Valve	5	40
315R001-NL	1"	T-Handle Full Port Press Ball Valve	4	20

PRBL Series F1807 Pex X Press Ball Valve

RAVEN
SPECIALTY PRODUCTS

F1807 Pex X Press Connections • Lead Free

ASTM
F1807
CRIMP PEX



PRESS
CONNECT

- Dezincification Resistant (DZR) Lead Free Brass Material
- Blow Out Proof Brass Stem
- Packing Nut, O-ring & Packing on the Stem Seal
- Max Pressure Rating: 250 CWP / 150 WSP
- Temperature Range: -20°F to 300°F
- IAPMO: NSF/ANSI-61, NSF/ANSI-372, IGC-157
- Press Ends Conform to ANSI Z1157
- Pex Ends Conform to ASTM F1807



PART #	SIZE	DESCRIPTION	INNER	MASTER
PRBL-012-NL	1/2"	F1807 PEX x Press Ball Valve	5	50
PRBL-034-NL	3/4"	F1807 PEX x Press Ball Valve	5	40
PRBL-001-NL	1"	F1807 PEX x Press Ball Valve	4	20

FRBL Series F1960 Pex X Press Ball Valve

RAVEN
SPECIALTY PRODUCTS

F1960 Pex X Press Connections • Lead Free

ASTM
F1960
EXPANSION PEX



PRESS
CONNECT

- Dezincification Resistant (DZR) Lead Free Brass Material
- Blow Out Proof Brass Stem
- Packing Nut, O-ring & Packing on the Stem Seal
- Max Pressure Rating: 250 CWP / 150 WSP
- Temperature Range: -20°F to 300°F
- IAPMO: NSF/ANSI-61, NSF/ANSI-372, IGC-157
- Press Ends Conform to ANSI Z1157



PART #	SIZE	DESCRIPTION	INNER	MASTER
FRBL-012-NL	1/2"	F1960 PEX x Press Ball Valve	5	50
FRBL-034-NL	3/4"	F1960 PEX x Press Ball Valve	5	40
FRBL-001-NL	1"	F1960 PEX x Press Ball Valve	4	20

Full Line of Press x Pex Adapters & Tees available. See our Pex products section of our catalog.

newinnovation

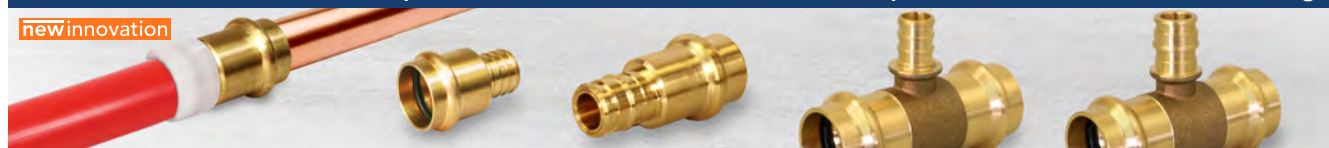

PUSH-FIT BALL VALVES

Push-Fit Ball Valve



Lead Free • Full Port • Forged Brass Body •



- Dezincification Resistant (DZR) Lead Free Brass Material
- Full Port Ball Valve Design
- Single Lever Heavy Duty Rust Resistant Handle with Vinyl Grip
- EPDM O-Ring for Leak free seals
- Connects PEX, CPVC or Copper Pipe in any Installation
- Quick and Easy, Removable and Re-Usable Installation
- Certified to 200 PSI WOG and 200°F
- Certified by UPC/IAMPO to Meet Lead Free Potable Water Laws
- ANSI/NSF-61-G Compliant
- AWWA C800 Compliant
- Meets ASME B1.20.1 ASSE 1061
- ISO:9001 Approved Manufacturer

CONNECTS TO
 PEX
 CPVC
 COPPER



- Stainless Steel Gripper
- EPDM Rubber O-Ring
- Plastic Release Collar
- Forged Brass Material



Push x Push 1/4 Turn Ball Valve



Lead Free • Full Port • Forged Brass Body



PART #	SIZE	DESCRIPTION	INNER	MASTER
UPBV12	1/2"	Push Ball Valve	5	50
UPBV34	3/4"	Push Ball Valve	5	40
UPBV1	1"	Push Ball Valve	4	20

Pex x FIP 1/4 Turn Ball Valve



Lead Free • Full Port • Forged Brass Body



PART #	SIZE	DESCRIPTION	INNER	MASTER
UPBVF12	1/2"	Push x FIP Ball Valve	5	50
UPBVF34	3/4"	Push x FIP Ball Valve	5	40
UPBVF1	1"	Push x FIP Ball Valve	4	20

Please see the entire line of Push Fittings in our catalog or visit us online at everflowsupplies.com/pushlock



F1807 PEX BALL VALVES



600P Series F1807 Pex Valve

CSA Certified • Lead Free • Full Port • 600 WOG

ASTM
F1807
CRIMP PEX



- Dezincification Resistant (DZR) Lead Free Brass Material
- Pex Ends Conform to ASTM F1807
- Blow Out Proof Stem Design
- Stainless Steel Ball
- Vinyl Grip Lever Handle
- 600 psi (WOG) 150 psi (WSP) Service
- Temperature Range : -20°F to 300°F



PART #	SIZE	DESCRIPTION	INNER	MASTER
600P012-NL	1/2"	Pex Ball Valve	10	100
600P034-NL	3/4"	Pex Ball Valve	10	100
600P001-NL	1"	Pex Ball Valve	5	50
600P114-NL	1-1/4"	Pex Ball Valve	5	25
600P112-NL	1-1/2"	Pex Ball Valve	5	25
600P002-NL	2"	Pex Ball Valve	2	12

615P Series T-Handle F1807 Pex Ball Valve

T-Handle with Vinyl Grip • CSA Certified • Lead Free • Full Port • 600 WOG

ASTM
F1807
CRIMP PEX



- Dezincification Resistant (DZR) Lead Free Brass Material
- Blow Out Proof Stem Design
- Stainless Steel Ball
- Pex Ends Conform to ASTM F1807
- 600 psi WOG 150 psi WSP
- Temp Range : -20°F to 300°F
- CSA Certified 3/8"- 2"
- Conforms to NSF/ANSI-61,372, NSF/ANSI-14 , IGC-157
- ISO:9001 Approved Manufacturer



PART #	SIZE	DESCRIPTION	INNER	MASTER
615P012-NL	1/2"	Pex T-Handle Ball Valve	10	100
615P034-NL	3/4"	Pex T-Handle Ball Valve	10	100
615P001-NL	1"	Pex T-Handle Ball Valve	5	50

405P Series F1807 Pex Ball Valve with Drain

Purge Drain • CSA Certified • Lead Free • Full Port • 600 WOG

ASTM
F1807
CRIMP PEX



- Dezincification Resistant (DZR) Lead Free Brass Material
- Blow Out Proof Stem Design
- Stainless Steel Ball
- Pex Ends Conform to ASTM F1807
- 600 psi (WOG) 150 psi (WSP) Service
- Temperature Range : -20°F to 300°F



PART #	SIZE	DESCRIPTION	INNER	MASTER
405P012-NL	1/2"	Pex Ball Valve w/ Drain	10	100
405P034-NL	3/4"	Pex Ball Valve w/ Drain	10	100
405P001-NL	1"	Pex Ball Valve w/ Drain	5	50

F1807 PEX BALL VALVES



G-600P Series F1807 Pex Ball Valve

Lead Free • Full Port • 400 WOG

ASTM
F1807
CRIMP PEX



- Dezincification Resistant (DZR) Lead Free Brass Material
- Blow Out Proof Stem Design
- Stainless Steel Ball
- PTFE Seats
- Vinyl Grip Lever Handle
- Pex Ends Conform to ASTM F1807
- Pressure Rating: 400PSI
- Complies with IGC157
- Meets NSF/ANSI 61-8



PART #	SIZE	DESCRIPTION	INNER	MASTER
G-600P012-NL	1/2"	Pex Ball Valve	10	100
G-600P034-NL	3/4"	Pex Ball Valve	10	100
G-600P001-NL	1"	Pex Ball Valve	5	50

G-615P Series T-Handle F1807 Pex Ball Valve

T-Handle • Lead Free • Full Port • 400 WOG

ASTM
F1807
CRIMP PEX



- Dezincification Resistant (DZR) Lead Free Brass Material
- Blow Out Proof Stem Design
- Stainless Steel Ball
- PTFE Seats
- Pex Ends Conform to ASTM F1807
- Pressure Rating: 400 psi WOG
- Complies with IGC157
- Meets NSF/ANSI 61-8



PART #	SIZE	DESCRIPTION	INNER	MASTER
G-615P012-NL	1/2"	Pex Ball Valve w/ T-Handle	10	100
G-615P034-NL	3/4"	Pex Ball Valve w/ T-Handle	10	100
G-615P001-NL	1"	Pex Ball Valve w/ T-Handle	5	50

PMBV Series F1807 Pex X MIP Ball Valve

T-Handle With Vinyl Grip • Lead Free • 600 WOG

ASTM
F1807
CRIMP PEX



- Dezincification Resistant (DZR) Lead Free Brass Material
- Blow Out Proof Stem Design
- Stainless Steel Ball
- Pex Ends Conform to ASTM F1807
- Vinyl Grip T-Handle
- 600 psi (WOG) 150 psi (WSP) Service
- Temperature Range : -20°F to 300°F



PART #	SIZE	DESCRIPTION	INNER	MASTER
PMBV-012-NL	1/2"	Pex X MIP Ball Valve	10	100
PMBV-034-NL	3/4"	Pex X MIP Ball Valve	10	100

F1807 PEX BALL VALVES



PSBL Series F1807 Pex X SWT Ball Valve

Lead Free • Vinyl Grip Handle • 600 WOG

ASTM
F1807
CRIMP PEX



- Dezincification Resistant (DZR) Lead Free Brass Material
- Forged Brass Body
- Blow Out Proof Stem Design
- Stainless Steel Ball
- Pex Ends Conform to ASTM F1807
- Solder-Joint conform ASME B16.22
- 600 psi WOG 150 psi WSP Service
- Temperature Range : -20°F to 300°F
- Conforms to NSF/ANSI-61, NSF/ANSI-372 , NSF/ANSI-14



PART #	SIZE	DESCRIPTION	INNER	MASTER
PSBL-012-NL	1/2"	Pex X SWT Ball Valve	10	100
PSBL-034-NL	3/4"	Pex X SWT Ball Valve	10	100
PSBL-001-NL	1"	Pex X SWT Ball Valve	5	50

PSBV Series F1807 Pex X SWT T-Handle Ball Valve

T-Handle With Vinyl Grip • Lead Free • 600 WOG

ASTM
F1807
CRIMP PEX



- Dezincification Resistant (DZR) Lead Free Brass Material
- Blow Out Proof Stem
- Stainless Steel Ball
- 600 psi WOG 150 psi WSP
- Temperature Range : -20°F to 300°F
- Pex Ends Conform to ASTM F1807
- Sweat Ends Conforms to ASME B16.22
- Conforms to NSF/ANSI-61, NSF/ANSI-372, NSF/ANSI-14
- CSA Certified
- ISO:9001 Approved Manufacturer



PART #	SIZE	DESCRIPTION	INNER	MASTER
PSBV-012-NL	1/2"	Pex X SWT T-Handle Ball Valve	10	100
PSBV-034-NL	3/4"	Pex X SWT T-Handle Ball Valve	10	100
PSBV-001-NL	1"	Pex X SWT T-Handle Ball Valve	5	50

848PS Series Pex X SWT T-Handle Ball Valve with Drain

Purge Drain • T-Handle With Vinyl Grip • Lead Free • 600 WOG

ASTM
F1807
CRIMP PEX



- Dezincification Resistant (DZR) Lead Free Brass Material
- Blow Out Proof Stem Design
- Stainless Steel Ball
- Pex Ends Conform to ASTM F1807
- Vinyl Grip T-Handle
- 600 psi (WOG) 150 psi (WSP) Service
- Temperature Range : -20°F to 300°F



PART #	SIZE	DESCRIPTION	INNER	MASTER
848PS012-NL	1/2"	Pex X SWT Ball Valve w/ Drain	10	100

RAVEN
SPECIALTY PRODUCTS

F1807 PEX BALL VALVES

800P Series F1807 Pex Ball Valve

RAVEN
SPECIALTY PRODUCTS

CSA Certified • Lead Free • Full Port • 600 WOG

ASTM
F1807
CRIMP PEX



- Dezincification Resistant (DZR) Lead Free Brass Material
- Pex Ends Conform to ASTM F1807
- Blow Out Proof Stem Design
- Stainless Steel Ball
- Vinyl Grip Lever Handle
- 600 psi (WOG) 150 psi (WSP) Service
- Temperature Range : -20° F to 300° F



PART #	SIZE	DESCRIPTION	INNER	MASTER
800P012-NL	1/2"	Pex Ball Valve	10	100
800P034-NL	3/4"	Pex Ball Valve	10	100
800P001-NL	1"	Pex Ball Valve	5	50

800PT Series F1807 Pex T-Handle Ball Valve

RAVEN
SPECIALTY PRODUCTS

T-Handle with Vinyl Grip • CSA Certified • Lead Free • Full Port • 600 WOG

ASTM
F1807
CRIMP PEX



- Dezincification Resistant (DZR) Lead Free Brass Material
- Blow Out Proof Stem Design
- Stainless Steel Ball
- Pex Ends Conform to ASTM F1807
- Vinyl Grip T-Handle
- 600 psi (WOG) 150 psi (WSP) Service
- Temperature Range : -20° F to 300° F



PART #	SIZE	DESCRIPTION	INNER	MASTER
800P012T-NL	1/2"	Pex T-Handle Ball Valve	10	100
800P034T-NL	3/4"	Pex T-Handle Ball Valve	10	100
800P001T-NL	1"	Pex T-Handle Ball Valve	5	50

825P Series F1807 Pex Ball Valve with Drain

RAVEN
SPECIALTY PRODUCTS

Purge Drain • CSA Certified • Lead Free • Full Port • 600 WOG

ASTM
F1807
CRIMP PEX



- Dezincification Resistant (DZR) Lead Free Brass Material
- Blow Out Proof Stem Design
- Stainless Steel Ball
- Pex Ends Conform to ASTM F1807
- Vinyl Grip Lever Handle
- 600 psi (WOG) 150 psi (WSP) Service
- Temperature Range : -20° F to 300° F



PART #	SIZE	DESCRIPTION	INNER	MASTER
825P012-NL	1/2"	Pex Ball Valve w/ Drain	10	100
825P034-NL	3/4"	Pex Ball Valve w/ Drain	10	100
825P001-NL	1"	Pex Ball Valve w/ Drain	5	50

F1807 & F1960 PEX BALL VALVES

806P Series F1807 Pex Drop Ear Ball Valve

RAVEN
SPECIALTY PRODUCTS

Solid Brass Drop Ears • Lead Free • 600 WOG

ASTM
F1807
CRIMP PEX



- Dezincification Resistant (DZR) Lead Free Brass Material
- Elongated Mounting Ears For Easy Installation
- Stainless Steel Ball
- PTFE Seats
- Pex Ends Conform to ASTM F1807
- Conforms to NSF/ANSI-61, NSF/ANSI-372, NSF/ANSI-14
- 600 psi (WOG) 150 psi (WSP) Service
- Temperature Range : -20°F to 300°F



PART #	SIZE	DESCRIPTION	INNER	MASTER
806P012-NL	1/2"	Pex Ball Drop Ear Ball Valve	20	100
806P034-NL	3/4"	Pex Ball Drop Ear Ball Valve	10	60
806P001-NL	1"	Pex Ball Drop Ear Ball Valve	10	60

807P Series F1807 Pex Drop Ear Ball Valve w/Drain

RAVEN
SPECIALTY PRODUCTS

Purge Drain • Solid Brass Drop Ears • Lead Free • 600 WOG

ASTM
F1807
CRIMP PEX



- Dezincification Resistant (DZR) Lead Free Brass Material
- Elongated Mounting Ears For Easy Installation
- Stainless Steel Ball
- PTFE Seats
- Pex Ends Conform to ASTM F1807
- Conforms to NSF/ANSI-61, NSF/ANSI-372, NSF/ANSI-14
- 600 psi (WOG) 150 psi (WSP) Service
- Temperature Range : -20°F to 300°F



PART #	SIZE	DESCRIPTION	INNER	MASTER
807P012-NL	1/2"	Pex Ball Valve w/ Drain	20	100
807P034-NL	3/4"	Pex Ball Valve w/ Drain	10	60
807P001-NL	1"	Pex Ball Valve w/ Drain	10	60

800W Series F1960 Pex Ball Valve

RAVEN
SPECIALTY PRODUCTS

CSA Certified • Lead Free • Full Port • 600 WOG

ASTM
F1960
EXPANSION PEX



- Dezincification Resistant (DZR) Lead Free Brass Material
- Blow Out Proof Stem Design
- Forged Brass
- Stainless Steel Ball
- Expansion Pex Ends Conform to ASTM F1960
- Vinyl Grip Lever Handle
- 600 psi (WOG) 150 psi (WSP) Service
- Temperature Range : -20°F to 300°F



PART #	SIZE	DESCRIPTION	INNER	MASTER
800W012-NL	1/2"	F1960 Pex Ball Valve	10	100
800W034-NL	3/4"	F1960 Pex Ball Valve	10	100
800W001-NL	1"	F1960 Pex Ball Valve	10	100

F1960 PEX BALL VALVES



600F Series F1960 Pex Ball Valve

CSA Certified • Lead Free • Full Port • 600 WOG



- Dezincification Resistant (DZR) Lead Free Brass Material
- Blow Out Proof Stem Design
- Stainless Steel Ball
- Vinyl Grip Lever Handle
- Expansion Pex Ends Conform to ASTM F1960
- Conforms to NSF/ANSI-61, NSF/ANSI-372, NSF/ANSI-14
- 400 psi WOG 150 psi WSP Service
- Temperature Range : -20°F to 300°F



PART #	SIZE	DESCRIPTION	INNER	MASTER
600F012-NL	1/2"	F1960 Pex Ball Valve	10	100
600F034-NL	3/4"	F1960 Pex Ball Valve	10	100
600F001-NL	1"	F1960 Pex Ball Valve	10	100
600F112-NL	1-1/2"	F1960 Pex Ball Valve	10	100
600F134-NL	1-3/4"	F1960 Pex Ball Valve	10	100
600F002-NL	2"	F1960 Pex Ball Valve	10	100

615F Series F1960 Pex T-Handle Ball Valve

CSA Certified • Lead Free • Full Port • 600 WOG



- Dezincification Resistant (DZR) Lead Free Brass Material
- Blow Out Proof Stem Design
- Stainless Steel Ball
- Vinyl Grip T-Handle
- Expansion Pex Ends Conform to ASTM F1960
- Conforms to NSF/ANSI-61, NSF/ANSI-372, NSF/ANSI-14
- 400 psi WOG 150 psi WSP Service
- Temperature Range : -20°F to 300°F



PART #	SIZE	DESCRIPTION	INNER	MASTER
615F012-NL	1/2"	F1960 Pex t-Handle Ball Valve	10	100
615F034-NL	3/4"	F1960 Pex t-Handle Ball Valve	10	100
615F001-NL	1"	F1960 Pex t-Handle Ball Valve	10	100

405 Series F1960 Pex Ball Valve w/ Drain

Purge Drain • CSA Certified • Lead Free • Full Port • 600 WOG



- Dezincification Resistant (DZR) Lead Free Brass Material
- Blow Out Proof Stem Design
- Stainless Steel Ball
- Vinyl Grip Lever Handle
- Expansion Pex Ends Conform to ASTM F1960
- Conforms to NSF/ANSI-61, NSF/ANSI-372, NSF/ANSI-14
- 400 psi WOG 150 psi WSP Service
- Temperature Range : -20°F to 300°F



PART #	SIZE	DESCRIPTION	INNER	MASTER
405F012-NL	1/2"	F1960 Pex Ball Valve	10	100
405F034-NL	3/4"	F1960 Pex Ball Valve	10	100
405F001-NL	1"	F1960 Pex Ball Valve	10	100

F1960 PEX BALL VALVES

825W Series F1960 Ball Valve w/ Drain



Purge Drain • CSA Certified • Lead Free • Full Port • 600 WOG



- Dezincification Resistant (DZR) Lead Free Brass Material
- Blow Out Proof Stem Design
- Stainless Steel Ball
- Expansion Pex Ends Conform to ASTM F1960
- Vinyl Grip Lever Handle
- 600 psi WOG 150 psi WSP Service
- Temperature Range : -20°F to 300°F



PART #	SIZE	DESCRIPTION	INNER	MASTER
825W-012-NL	1/2"	F1960 Pex Ball Valve w/Drain	20	100
825W-034-NL	3/4"	F1960 Pex Ball Valve w/Drain	20	100
825W-034-NL	1"	F1960 Pex Ball Valve w/Drain	10	100

806W Series F1960 Drop Ear Pex Valve



Solid Brass Drop Ears • Lead Free • 600 WOG



- Dezincification Resistant (DZR) Lead Free Brass Material
- Elongated Mounting Ears For Easy Installation
- Stainless Steel Ball
- PTFE Seats
- Expansion Pex Ends Conform to ASTM F1960
- Conforms to NSF/ANSI-61, NSF/ANSI-372, NSF/ANSI-14
- 600 psi WOG 150 psi (WSP) Service
- Temperature Range : -20°F to 300°F



PART #	SIZE	DESCRIPTION	INNER	MASTER
806W-012-NL	1/2"	F1960 Pex Drop Ear Ball Valve	10	100
806W-034-NL	3/4"	F1960 Pex Drop Ear Ball Valve	10	100

807W Series F1960 Drop Ear Pex Valve w/ Drain



Purge Drain • Solid Brass Drop Ears • Lead Free • 600 WOG



- Dezincification Resistant (DZR) Lead Free Brass Material
- Elongated Mounting Ears For Easy Installation
- Stainless Steel Ball
- PTFE Seats
- Expansion Pex Ends Conform to ASTM F1960
- Conforms to NSF/ANSI-61, NSF/ANSI-372, NSF/ANSI-14
- 600 psi WOG 150 psi WSP Service
- Temperature Range : -20°F to 300°F



PART #	SIZE	DESCRIPTION	INNER	MASTER
807W-012-NL	1/2"	F1960 Pex Ball Valve	20	100
807W-034-NL	3/4"	F1960 Pex Ball Valve	10	50

F1960 PEX BALL VALVES

FSBL Series F1960 Pex x SWT Ball Valve

RAVEN
SPECIALTY PRODUCTS

Lead Free • Vinyl Grip Handle • 600 WOG

ASTM
F1960
EXPANSION PEX



- Dezincification Resistant (DZR) Lead Free Brass Material
- Forged Brass Body
- Blow Out Proof Stem Design
- Stainless Steel Ball
- Expansion Pex Ends Conform to ASTM F1960
- Solder-Joint Conforms to ASME B16.22
- 600 psi WOG 150 psi WSP Service
- Temperature Range : -20°F to 300°F
- Conforms to NSF/ANSI-61, NSF/ANSI-372 , NSF/ANSI-14



PART #	SIZE	DESCRIPTION	INNER	MASTER
FSBL-012-NL	1/2"	F1960 Pex X SWT Ball Valve	10	100
FSBL-034-NL	3/4"	F1960 Pex X SWT Ball Valve	10	100
FSBL-001-NL	1"	F1960 Pex X SWT Ball Valve	5	50

FFBL Series F1960 Pex x FIP Ball Valve

RAVEN
SPECIALTY PRODUCTS

Lead Free • Vinyl Grip Handle • 600 WOG

ASTM
F1960
EXPANSION PEX



- Dezincification Resistant (DZR) Lead Free Brass Material
- Forged Brass Body
- Blow Out Proof Stem Design
- Stainless Steel Ball
- Expansion Pex Ends Conform to ASTM F1960
- 600 psi WOG 150 psi WSP Service
- Temperature Range : -20°F to 300°F
- Conforms to NSF/ANSI-61, NSF/ANSI-372 , NSF/ANSI-14



PART #	SIZE	DESCRIPTION	INNER	MASTER
FFBL-012-NL	1/2"	F1960 Pex X FIP Ball Valve	10	100
FFBL-034-NL	3/4"	F1960 Pex X FIP Ball Valve	10	100
FFBL-001-NL	1"	F1960 Pex X FIP Ball Valve	5	50

FMBL Series F1960 Pex x MIP Ball Valve

RAVEN
SPECIALTY PRODUCTS

Lead Free • Vinyl Grip Handle • 600 WOG

ASTM
F1960
EXPANSION PEX



- Dezincification Resistant (DZR) Lead Free Brass Material
- Forged Brass Body
- Blow Out Proof Stem Design
- Stainless Steel Ball
- Expansion Pex Ends Conform to ASTM F1960
- 600 psi WOG 150 psi WSP Service
- Temperature Range : -20°F to 300°F
- Conforms to NSF/ANSI-61, NSF/ANSI-372 , NSF/ANSI-14



PART #	SIZE	DESCRIPTION	INNER	MASTER
FMBL-012-NL	1/2"	F1960 Pex X MIP Ball Valve	10	100
FMBL-034-NL	3/4"	F1960 Pex X MIP Ball Valve	10	100
FMBL-001-NL	1"	F1960 Pex X MIP Ball Valve	5	50

FLANGE BALL VALVES



520R Series Press Flange Ball Valve with Purge

Rotating Flange • Press Connection • With Purge Drain • Full Port • Two Valve Set



- Rotating Outer Flange allows 360 degree motion for easier installation
- Includes Gaskets and Nuts
- Vinyl Grip Lever Handle with Optinal T-Handle Included
- Heavy Duty Rust Resistant Brass Body
- Blow Out Proof Stem Design
- PTFE Seats and Seals
- Ends Comply With ANSI.B.20.1, ANSI.B.16.18

PRESS PART #	SIZE	DESCRIPTION	INNER	MASTER
520R034	3/4"	Press Rotating Flange Ball Valve With Purge	1 set	12
520R001	1"	Press Rotating Flange Ball Valve With Purge	1 set	12
520R114	1-1/4"	Press Rotating Flange Ball Valve With Purge	1 set	8
520R112	1-1/2"	Press Rotating Flange Ball Valve With Purge	1 set	8
520R002	2"	Press Rotating Flange Ball Valve With Purge	1 set	4

515R Series Flange Press Ball Valve

Rotating Flange • Press Connection • Full Port • Two Valve Set



- Includes Gaskets and Nuts
- Vinyl Grip Lever Handle with Optinal T-Handle Included
- Heavy Duty Rust Resistant Brass Body
- Blow Out Proof Stem Design
- PTFE Seats and Seals
- Ends Comply With ANSI.B.20.1, ANSI.B.16.18
- 600 psi WOG 150 psi WSP Service

PRESS PART #	SIZE	DESCRIPTION	INNER	MASTER
515R034	3/4"	Press Rotating Flange Ball Valve	1 set	12
515R001	1"	Press Rotating Flange Ball Valve	1 set	12
515R114	1-1/4"	Press Rotating Flange Ball Valve	1 set	8
515R112	1-1/2"	Press Rotating Flange Ball Valve	1 set	8
515R002	2"	Press Rotating Flange Ball Valve	1 set	4

510 Series Flange Ball Valve Set with Purge

With Purge Drain • Full Port • Two Valve Set



- Includes Gaskets and Nuts
- Vinyl Grip Lever Handle with Optinal T-Handle Included
- Heavy Duty Rust Resistant Brass Body
- Blow Out Proof Stem Design
- PTFE Seats and Seals
- Ends Comply With ANSI.B.20.1, ANSI.B.16.18
- 600 psi WOG 150 psi WSP Service

THREADED PART #	SWEAT PART #	SIZE	DESCRIPTION	INNER	MASTER
510T034	510C034	3/4"	Flange Ball Valve With Purge	1 set	12
510T001	510C001	1"	Flange Ball Valve With Purge	1 set	12
510T114	510C114	1-1/4"	Flange Ball Valve With Purge	1 set	8
510T112	510C112	1-1/2"	Flange Ball Valve With Purge	1 set	8
510T002	-	2"	Flange Ball Valve With Purge	1 set	4

FLANGE BALL VALVES



505 Series Flange Ball Valve Set

Full Port • Two Valve Set



- Includes Gaskets and Nuts
- Vinyl Grip Lever Handle with Optimal T-Handle Included
- Heavy Duty Rust Resistant Brass Body
- Blow Out Proof Stem Design
- PTFE Seats and Seals
- Ends Comply With ANSI.B.20.1, ANSI.B.16.18
- 600 psi WOP 150 psi WSP Service

THREADED PART #	SWEAT PART #	SIZE	DESCRIPTION	INNER	MASTER
505T034	505C034	3/4"	Flange Ball Valve Less Purge	1 set	12
505T001	505C001	1"	Flange Ball Valve Less Purge	1 set	12
505T114	505C114	1-1/4"	Flange Ball Valve Less Purge	1 set	8
505T112	505C112	1-1/2"	Flange Ball Valve Less Purge	1 set	8
505T002	505C002	2"	Flange Ball Valve Less Purge	1 set	4

895 Series Flange Ball Valve with Purge

RAVEN
SPECIALTY PRODUCTS

With Purge Drain • Full Port



- Includes Gaskets and Nuts
- Vinyl Grip Lever Handle with Optimal T-Handle Included
- Purge Drain with Mini Vinyl Grip Lever Handle
- Heavy Duty Rust Resistant Brass Body
- Blow Out Proof Stem Design
- PTFE Seats and Seals
- Ends Comply With ANSI.B.20.1, ANSI.B.16.18
- 400 psi WOG 150 psi WSP Service

THREADED PART #	SWEAT PART #	SIZE	DESCRIPTION	INNER	MASTER
895T034	895C034	3/4"	Flange Ball Valve Wlth Purge	2	24
895T001	895C001	1"	Flange Ball Valve Wlth Purge	2	24
895T114	895C114	1-1/4"	Flange Ball Valve Wlth Purge	2	16
895T112	895C112	1-1/2"	Flange Ball Valve Wlth Purge	2	16
895T002	-	2"	Flange Ball Valve Wlth Purge	2	8

890 Series Flange Ball Valve

RAVEN
SPECIALTY PRODUCTS

Full Port



- Includes Gaskets and Nuts
- Vinyl Grip Lever Handle with Optimal T-Handle Included
- Purge Drain with Mini Vinyl Grip Lever Handle
- Heavy Duty Rust Resistant Brass Body
- Blow Out Proof Stem Design
- PTFE Seats and Seals
- Ends Comply With ANSI.B.20.1, ANSI.B.16.18
- 400 psi WOG 150 psi WSP Service

THREADED PART #	SWEAT PART #	SIZE	DESCRIPTION	INNER	MASTER
890T034	890C034	3/4"	Flange Ball Valve Less Purge	2	24
890T001	890C001	1"	Flange Ball Valve Less Purge	2	24
890T114	890C114	1-1/4"	Flange Ball Valve Less Purge	2	16
890T112	890C112	1-1/2"	Flange Ball Valve Less Purge	2	16
890T002	890C002	2"	Flange Ball Valve Less Purge	2	8

BALL VALVES

Tankless Water Heater Valves

FLEXTRON®
NSF Compliant • Lead Free • Full Port Main Flow Channel • Available in Press, Pex, IPS & SWT

- Set of 2 Heavy Duty Forged Brass Ball Valves
- Full Port Main Flow Channel
- Large Drain Port Outlets
- Easy Identification of Hot & Cold Valves
- Lead Free Compliant



IPS



PRESS



SWT



PEX

PRESS
CONNECT

 ASTM
F1807
CRIMP PEX

PRESS
CONNECT

 ASTM
F1807
CRIMP PEX

Tankless Water Heater Isolation Valve Kit

Hot/Cold Tankless Isolation Valves & Pressure Relief Valve

PART #	SIZE	CONNECTION	DESCRIPTION	QTY
FTGV-ISO34-T-KIT-LF	3/4"	Threaded	1 Set H/C Iso. Valves + 3/4" Relief Valve	1 Set
FTGV-ISO1-T-KIT-LF	1"	Threaded	1 Set H/C Iso. Valves + 3/4" Relief Valve	1 Set
FTGV-ISO34-S-KIT-LF	3/4"	Sweat	1 Set H/C Iso. Valves + 3/4" Relief Valve	1 Set
FTGV-ISO1-S-KIT-LF	1"	Sweat	1 Set H/C Iso. Valves + 3/4" Relief Valve	1 Set
FTGV-ISO34-R-KIT-LF	3/4"	Press	1 Set H/C Iso. Valves + 3/4" Relief Valve	1 Set
FTGV-ISO1-R-KIT-LF	1"	Press	1 Set H/C Iso. Valves + 3/4" Relief Valve	1 Set
FTGV-ISO34-P-KIT-LF	3/4"	PEX	1 Set H/C Iso. Valves + 3/4" Relief Valve	1 Set
FTGV-ISO1-P-KIT-LF	1"	PEX	1 Set H/C Iso. Valves + 3/4" Relief Valve	1 Set

Tankless Water Heater Isolation Valve

Set of Hot/Cold Tankless Isolation Valves

PART #	SIZE	CONNECTION	DESCRIPTION	QTY
FTGV-ISO34-T-LF	3/4"	Threaded	1 Set H/C Iso. Valves	1 Set
FTGV-ISO1-T-LF	1"	Threaded	1 Set H/C Iso. Valves	1 Set
FTGV-ISO34-S-LF	3/4"	Sweat	1 Set H/C Iso. Valves	1 Set
FTGV-ISO1-S-LF	1"	Sweat	1 Set H/C Iso. Valves	1 Set
FTGV-ISO34-R-LF	3/4"	Press	1 Set H/C Iso. Valves	1 Set
FTGV-ISO1-R-LF	1"	Press	1 Set H/C Iso. Valves	1 Set
FTGV-ISO34-P-LF	3/4"	PEX	1 Set H/C Iso. Valves	1 Set
FTGV-ISO1-P-LF	1"	PEX	1 Set H/C Iso. Valves	1 Set

Pressure Relief Valve

- Fully automatic valve reseats itself after relieving pressure
- Suitable for tankless or closed-loop hot water systems



PART #	SIZE	CONNECTION	DESCRIPTION	QTY
FTGV-PRV034	3/4"	Threaded	1 Pressure Relief Valve	1

706 Series High Flow Drain Ball Valve

RAVEN
SPECIALTY PRODUCTS

Full Port • Reversible Handle • 3 Way Adjustable • Hose Drain

PRESS
CONNECT

The 706 Series Ball Drain Valve enables quick isolation & drainage of any portion of a piped system. Ideal to install directly after a water meter to winterize a home and purge entire system with a simple quarter turn action. Reversible Handle allows for draining from either side of ball. Eliminates many leak paths and saves significant labor.

- Dezincification Resistant (DZR) Lead Free Brass Material
- Available in Sweat and Press Ends
- Heavy Duty Forged Brass Construction
- High Flow Hose Drain
- Reversible Handle
- Blow-out Proof Stem
- Individually controlled drain outlets
- Adjustable Packing Gland

SWT High Flow Drain Ball Valve



PART #	SIZE	DESCRIPTION	INNER	MASTER
706C012-NL	1/2"	SWT Ball Valve	6	36
706C034-NL	3/4"	SWT Ball Valve	6	36
706C001-NL	1"	SWT Ball Valve	5	30
706C114-NL	1-1/4"	SWT Ball Valve	5	20
706C112-NL	1-1/2"	SWT Ball Valve	5	20
706C002-NL	2"	SWT Ball Valve	2	12



Press High Flow Drain Ball Valve



PART #	SIZE	DESCRIPTION	INNER	MASTER
706R012-NL	1/2"	Press Ball Valve	6	36
706R034-NL	3/4"	Press Ball Valve	6	36
706R001-NL	1"	Press Ball Valve	5	30
706R114-NL	1-1/4"	Press Ball Valve	5	20
706R112-NL	1-1/2"	Press Ball Valve	5	20
706R002-NL	2"	Press Ball Valve	2	12



Valves with 3-Way adjustable flow path may be quickly and easily reconfigured to drain from either side of the ball. Simply remove the handle, turn the stem 180° and replace the handle.

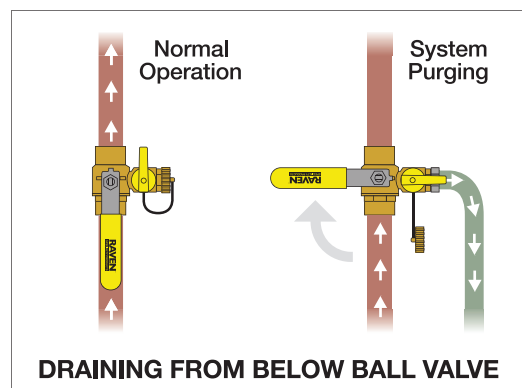
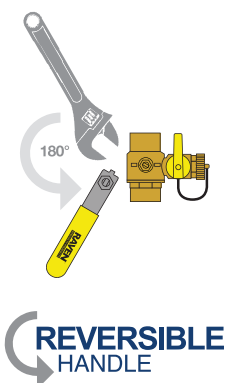
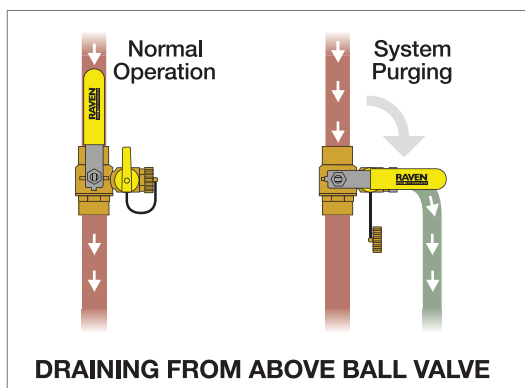

BALL VALVES

Navien® Style Manifold Assembly **RAVEN** SPECIALTY PRODUCTS

For Navien® Tank With Water Heater



- Eliminates 25 Leak Paths
- Saves Over 3.5 Hours of Labor
- Eliminates Costly Field Fabrication
- Avoids Precise Calculations
- Simplifies Future Maintenance
- Easy Installation for Navien® Systems
- Installation Kits Fit Over 200 Different Boilers

PART #	SIZE	DESCRIPTION	INNER	MASTER
NCM112	1-1/2"	Copper Manifold Assembly	1	1

Expansion Tank Isolator w/ Waste **RAVEN** SPECIALTY PRODUCTS

FIP x FIP • Forged Brass Body



- Isolates Allowing Release of Pressure for Tank Removal
- Prevents Hazardous Water Spray
- Avoids Need to Drain System

PART #	SIZE	DESCRIPTION	INNER	MASTER
1127	1/2"M x 1/2"F	Tank Isolator	10	100

Mini Ball Valve

Lead Free • Full Port • Butterfly Handle • Forged Brass Body



- Dezincification Resistant (DZR) Lead Free Brass Material
- Blow Out Proof Stem Design
- Forged Brass Body
- Double EPDM O-Rings
- Lead Free
- Thread End Complies with ANSI B1.20.1
- 600 psi WOG 150 psi WSP Service
- Temperature Range : 100 PSI at 180°F



PART #	SIZE	DESCRIPTION	INNER	MASTER
615MF014-NL	1/4" MIP x 1/4" FIP	Mini Ball Valve	10	120
615MF018-NL	1/8" MIP x 1/8" FIP	Mini Ball Valve	10	120
615FF014-NL	1/4" FIP x 1/4" FIP	Mini Ball Valve	5	50
615FF018-NL	1/8" FIP x 1/8" FIP	Mini Ball Valve	5	50

Boiler Trim Isolation Valves **RAVEN** SPECIALTY PRODUCTS

Air Vent & Gauge Isolator • Forged Brass Body



- Extended Design for Airvent Isolation
- Vent Flag Won't Interfere with Ball Valve Operation
- Ball Pressure Rating 125 Lbs.
- Maximum Temperature 180°F
- Avoids Need to Drain System to Swap Gauges

PART #	SIZE	DESCRIPTION	INNER	MASTER
1818MF	1/8"M x 1/8"F	Air Vent Isolator	21	336
1414MF	1/4"M x 1/4"F	Gauge Isolator	21	336
3838MF	3/8"M x 3/8"F	Gauge Isolator	21	336
1212MF	1/2"M x 1/2"F	Gauge Isolator	16	320

Purge Station with Boiler Drain

RAVEN
SPECIALTY PRODUCTS

Heavy Duty Forged Brass Body • Reversible Steel Lever Handle

- Designed for Easy Purge of Water System
- For Residential & Commercial Use with WOG
- IPS End Complies with ANSI B1.20.1
- Heavy Duty Forged Brass Body
- Chrome Plated Brass Ball w/ PTFE Seats
- Blowout Proof Stem
- Adjustable Packing Nut
- Reversible Vinyl Coated Steel Lever Handle
- Includes Purge Station & Boiler Drain
- Winterizes Your House with Single 1/4 Turn Action
- Hose End Complies with ANSI B1.20.7
- Conforms to Federal Spec WWV-35C
- Assembly Required



PART #	SIZE	DESCRIPTION	INNER	MASTER
PS34CC	3/4" C x C	Purge Station w/ Boiler Drain	1	25
PS34CF	3/4" C x F	Purge Station w/ Boiler Drain	1	25
PS34CM	3/4" C x M	Purge Station w/ Boiler Drain	1	25
PS1CC	1" C x C	Purge Station w/ Boiler Drain	1	25
PS1CF	1" C x F	Purge Station w/ Boiler Drain	1	25

Single Shut Off Expansion Tank Valve

Labor Saving Design • Brass Body

- Isolates Expansion Tank & Allows the Boiler to Fill at 0 Pressure
- Installs Between Expansion Tank & Air Scoop
- Labor Saving Design - Saves at Least 8 Soldered Joints
- Allows for Easy Maintenance of Heating System

PART #	SIZE	DESCRIPTION	INNER	MASTER
1129	1/2"	Male x Female w/ Waste & Branch	10	50

Double Shut Off Expansion Tank Valve

Labor Saving Design • Brass Body • Branch with Shutoff

- Isolates Expansion Tank & Allows the Boiler to Fill at 0 Pressure
- Installs Between Expansion Tank & Air Scoop
- Labor Saving Design - Saves at Least 8 Soldered Joints
- Allows for Easy Maintenance of Heating System

PART #	SIZE	DESCRIPTION	INNER	MASTER
1130	1/2"	Male x Female w/ Waste & Branch w/shutoff	1	1

CHECK VALVES



210 Series Swing Check Valve

CSA Approved • Cast Brass Body • Cast Brass Disc • Prevent Backflow



IPS



SWT

- 200 PSI WOG 125 PSI SWP
- Threaded Ends Comply with ANSI B2.1
- Solder Ends Comply with ANSI B16.18
- CSA Certified
- Conforms to NSF/ANSI-61/ 372

Lead Free Swing Check Valve



THREADED PART #	SWEAT PART #	SIZE	DESCRIPTION	INNER	MASTER
210T012-NL	210C012-NL	1/2"	Lead Free Swing Check Valve	10	100
210T034-NL	210C034-NL	3/4"	Lead Free Swing Check Valve	10	100
210T001-NL	210C001-NL	1"	Lead Free Swing Check Valve	5	50
210T114-NL	210C114-NL	1-1/4"	Lead Free Swing Check Valve	5	30
210T112-NL	210C112-NL	1-1/2"	Lead Free Swing Check Valve	5	30
210T002-NL	210C002-NL	2"	Lead Free Swing Check Valve	2	12
210T212-NL	210C212-NL	2-1/2"	Lead Free Swing Check Valve	1	8
210T003-NL	210C003-NL	3"	Lead Free Swing Check Valve	1	5
210T004-NL	210C004-NL	4"	Lead Free Swing Check Valve	1	4

Swing Check Valve



THREADED PART #	SWEAT PART #	SIZE	DESCRIPTION	INNER	MASTER
210T012	210C012	1/2"	Swing Check Valve	10	100
210T034	210C034	3/4"	Swing Check Valve	10	100
210T001	210C001	1"	Swing Check Valve	5	50
210T114	210C114	1-1/4"	Swing Check Valve	5	25
210T112	210C112	1-1/2"	Swing Check Valve	5	25
210T002	210C002	2"	Swing Check Valve	2	12
210T212	210C212	2-1/2"	Swing Check Valve	1	8
210T003	210C003	3"	Swing Check Valve	1	5
210T004	210C004	4"	Swing Check Valve	1	4

400 Series Press Swing Check Valve

Cast Brass Body • Cast Brass Disc • Press Ends • Prevent Backflow



- 200 PSI WOG 125 PSI SWP
- CSA Certified
- Conforms to NSF/ANSI-61/ 372
- Press Ends conform to ANSI Z1157



PART #	SIZE	DESCRIPTION	INNER	MASTER
400R012-NL	1/2"	Press Fit Swing Check Valve	10	160
400R034-NL	3/4"	Press Fit Swing Check Valve	10	120
400R001-NL	1"	Press Fit Swing Check Valve	5	60
400R114-NL	1-1/4"	Press Fit Swing Check Valve	5	40
400R112-NL	1-1/2"	Press Fit Swing Check Valve	5	30
400R002-NL	2"	Press Fit Swing Check Valve	2	24

CHECK VALVES & Y STRAINERS



Inline Spring Loaded Check Valve

Lead Free • Cast Brass Body



- Can be Installed in a Horizontal or Vertical Position
- Temperature Rating 180°F
- Cold Working Pressure (CWP): 200 psi. Non Shock
- Threaded Ends Comply ANSI B2.1
- Solder Ends Comply with ANSI B16.18
- Conforms to NSF/ANSI-61/372



THREADED PART #	SWEAT PART #	SIZE	DESCRIPTION	INNER	MASTER
150T012-NL	150C012-NL	1/2"	Inline Check Valve	10	100
150T034-NL	150C034-NL	3/4"	Inline Check Valve	10	80
150T100-NL	150C100-NL	1"	Inline Check Valve	6	60
150T114-NL	150C114-NL	1-1/4"	Inline Check Valve	4	40
150T112-NL	150C112-NL	1-1/2"	Inline Check Valve	5	30
150T200-NL	150C200-NL	2"	Inline Check Valve	5	20

Press Inline Spring Check Valve

Lead Free • Brass Body



- Can be Installed in a Horizontal or Vertical Position
- Temperature Rating 180°F
- Cold Working Pressure (CWP): 200 psi. Non Shock
- Press Ends conform to ANSI Z1157
- Conforms to NSF/ANSI-61/372



PRESS PART #	SIZE	DESCRIPTION	INNER	MASTER
150R012-NL	1/2"	Press Inline Check Valve	10	100
150R034-NL	3/4"	Press Inline Check Valve	10	80
150R100-NL	1"	Press Inline Check Valve	6	60
150R114-NL	1-1/4"	Press Inline Check Valve	4	40
150R112-NL	1-1/2"	Press Inline Check Valve	5	30
150R200-NL	2"	Press Inline Check Valve	5	20

Y-Strainer

With Plug • Bronze Body and Plug • Stainless Steel Mesh Screen



- Screwed Cap with Plug
- Stainless Steel Mesh Screen
- Temperature Rating 180°F
- Pressure rating 150 SWP
- Threaded Ends Comply with ANSI B2.1
- Solder Ends Comply with ANSI B16.18
- Conforms to NSF/ANSI-61/372



THREADED PART #	SWEAT PART #	SIZE	DESCRIPTION	INNER	MASTER
100T012-NL	100C012-NL	1/2"	Y-Strainer	12	48
100T034-NL	100C034-NL	3/4"	Y-Strainer	8	48
100T100-NL	100C100-NL	1"	Y-Strainer	8	32
100T114-NL	100C114-NL	1-1/4"	Y-Strainer	6	24
100T112-NL	100C112-NL	1-1/2"	Y-Strainer	2	16
100T200-NL	100C200-NL	2"	Y-Strainer	2	8

Y STRAINERS & GATE VALVES



105 Series Y-Strainer

Brass Body and Plug • Compact Design • Stainless Steel Mesh Screen



IPS

- Screwed Cap with Plug
- Stainless Steel Mesh Screen
- Temperature Rating 200°F
- Pressure rating 200 SWP
- Threaded Ends Comply with ANSI B1.20.1
- Conforms to NSF/ANSI-61/372



PART #	SIZE	DESCRIPTION	INNER	MASTER
105T012-NL	1/2"	Threaded Y-Strainer	12	48
105T034-NL	3/4"	Threaded Y-Strainer	8	48
105T100-NL	1"	Threaded Y-Strainer	8	32
105T114-NL	1-1/4"	Threaded Y-Strainer	6	24
105T112-NL	1-1/2"	Threaded Y-Strainer	2	16
105T200-NL	2"	Threaded Y-Strainer	2	8

105 Series Press Y-Strainer



Press Connection • Brass Body and Plug • Stainless Steel Mesh Screen



- Screwed Cap with Plug
- Stainless Steel Mesh Screen
- Temperature Rating 200°F
- Pressure rating 200 SWP
- Press Ends conform to ANSI Z1157
- Conforms to NSF/ANSI-61/372



PART #	SIZE	DESCRIPTION	INNER	MASTER
105R012-NL	1/2"	Press Y-Strainer	12	48
105R034-NL	3/4"	Press Y-Strainer	8	48
105R100-NL	1"	Press Y-Strainer	8	32
105R114-NL	1-1/4"	Press Y-Strainer	6	24
105R112-NL	1-1/2"	Press Y-Strainer	2	16
105R200-NL	2"	Press Y-Strainer	2	8

205R Series Press Gate Valve



Press Connection • Brass Body & Disc • 200 WOG



- Brass Body and Disc
- Non Rising Stem
- Cast Iron Wheel Handle
- Press Ends conform to ANSI Z1157
- 200 WOG Non Shock
- Temperature Range : 180°F
- Conforms to NSF/ANSI-61/ 372 Standards

PART #	SIZE	DESCRIPTION	INNER	MASTER
205R012	1/2"	Press Gate Valve	10	100
205R034	3/4"	Press Gate Valve	10	80
205R001	1"	Press Gate Valve	5	50
205R114	1-1/4"	Press Gate Valve	5	40
205R112	1-1/2"	Press Gate Valve	5	30
205R002	2"	Press Gate Valve	2	20



207 Series Heavy Duty Gate Valve

Cast Brass Body & Disc • 200 WOG

**HEAVY
DUTY**



- Heavy Duty Construction
- Cast Brass Body and Disc
- Non Rising Stem
- Cast Iron Wheel Handle
- Threaded Ends Comply with ANSI B1.20.1
- Solder Ends Comply with ANSI B16.18
- 200 WOG Non Shock
- Temperature Range : 180°F
- Conforms to NSF/ANSI-61/ 372 Standards



LEAD FREE	PART #	PART #	SIZE	DESCRIPTION	INNER	MASTER
	207T112-NL	207T012	1/2"	IPS Heavy Duty Gate Valve	10	100
	-	207T034	3/4"	IPS Heavy Duty Gate Valve	10	80
	-	207T001	1"	IPS Heavy Duty Gate Valve	5	50
	-	207T114	1-1/4"	IPS Heavy Duty Gate Valve	5	40
	-	207T112	1-1/2"	IPS Heavy Duty Gate Valve	5	30
	207T002-NL	207T002	2"	IPS Heavy Duty Gate Valve	2	20
	-	207T212	2-1/2"	IPS Heavy Duty Gate Valve	1	8
	-	207T003	3"	IPS Heavy Duty Gate Valve	1	6
	-	207T004	4"	IPS Heavy Duty Gate Valve	1	4

205 Series Brass Gate Valve

Cast Brass Body & Disc • 200 WOG



- Cast Brass Body and Disc
- Non Rising Stem
- Cast Iron Wheel Handle
- Threaded Ends Comply with ANSI B1.20.1
- Solder Ends Comply with ANSI B16.18
- 200 WOG Non Shock
- Temperature Range : 180°F
- Conforms to NSF/ANSI-61/ 372 Standards

Lead Free Brass Gate Valve



THREADED	PART #	SWEAT	PART #	SIZE	DESCRIPTION	INNER	MASTER
	205T014-NL	-		1/4"	Brass Gate Valve	10	100
	205T038-NL	-		3/8"	Brass Gate Valve	10	100
	205T012-NL	205C012-NL		1/2"	Brass Gate Valve	10	100
	205T034-NL	205C034-NL		3/4"	Brass Gate Valve	10	80
	205T001-NL	205C001-NL		1"	Brass Gate Valve	5	50
	205T114-NL	205C114-NL		1-1/4"	Brass Gate Valve	5	40
	205T112-NL	205C112-NL		1-1/2"	Brass Gate Valve	5	30
	205T002-NL	205C002-NL		2"	Brass Gate Valve	2	20
	205T212-NL	205C212-NL		2-1/2"	Brass Gate Valve	1	8
	205T003-NL	205C003-NL		3"	Brass Gate Valve	1	6
	205T004-NL	205C004-NL		4"	Brass Gate Valve	1	4

Brass Gate Valve



THREADED	PART #	SWEAT	PART #	SIZE	DESCRIPTION	INNER	MASTER
	205T014	-		1/4"	Gate Valve	10	100
	205T038	-		3/8"	Gate Valve	10	100
	205T012	205C012		1/2"	Gate Valve	10	100
	205T034	205C034		3/4"	Gate Valve	10	80
	205T001	205C001		1"	Gate Valve	5	50
	205T114	205C114		1-1/4"	Gate Valve	5	40
	205T112	205C112		1-1/2"	Gate Valve	5	30
	205T002	205C002		2"	Gate Valve	2	20
	205T212	205C212		2-1/2"	Gate Valve	1	8
	205T003	205C003		3"	Gate Valve	1	6
	205T004	205C004		4"	Gate Valve	1	4

GATE & STOP VALVES



205 Series Comp Brass Gate Valve

200 WOG Non Shock • Cast Brass Body & Disc • Compression Connection



- Non Rising Stem
- Cast Iron Wheel Handle
- Compression Ends
- 200 WOG Non Shock
- Temperature Range : 180°F
- Conforms to NSF/ANSI-61/ 372 Standards



LEAD FREE PART #	PART #	SIZE	DESCRIPTION	INNER	MASTER
205P012-NL	205P012	1/2"	Comp X Comp Brass Gate Valve	10	80
205P034-NL	205P034	3/4"	Comp X Comp Brass Gate Valve	10	60
205P001-NL		1"	Comp X Comp Brass Gate Valve	5	40

410 Series Stop and Waste Valve



Purge Drain • Lead Free • Forged Brass Body • 125 WOG



- Forged Brass Body
- Compression Style Stop Valve
- Threaded Ends Comply with ANSI B2.1
- Sweat Ends Conform to ASME B16.18
- Conforms to NSF/ANSI-61/ 372 Standards
- 125 WOG



THREADED PART #	SWEAT PART #	SIZE	DESCRIPTION	INNER	MASTER
410T012-NL	410C012-NL	1/2"	Stop and Waste Valve	10	80
410T034-NL	410C034-NL	3/4"	Stop and Waste Valve	10	60

Straight Short Globe Style Stop Valve



Lead Free • Forged Brass Body • 125 WOG



- Forged Brass Body
- Compression Style Stop Valve
- Threaded Ends Comply with ANSI B2.1
- Sweat Ends Conform to ASME B16.18
- Conforms to NSF/ANSI-61/ 372 Standards
- 125 WOG



THREADED PART #	SWEAT PART #	SIZE	DESCRIPTION	INNER	MASTER
73122-NL	73121-NL	1/2"	Short Globe Valve	10	100
73342-NL	73341-NL	3/4"	Short Globe Valve	10	100

Angle Short Globe Style Stop Valve



Lead Free • Forged Brass Body • 125 WOG



- Forged Brass Body
- Compression Style Stop Valve
- Threaded Ends Comply with ANSI B2.1
- Sweat Ends Conform to ASME B16.18
- Conforms to NSF/ANSI-61/ 372 Standards
- 125 WOG



THREADED PART #	SWEAT PART #	SIZE	DESCRIPTION	INNER	MASTER
74122-NL	74121-NL	1/2"	Short Globe Valve	10	100
74342-NL	74341-NL	3/4"	Short Globe Valve	10	100

GATE & STOP VALVES



Long Bonnet Gate Valve

Lead Free • Cast Brass Body • 200 WOG

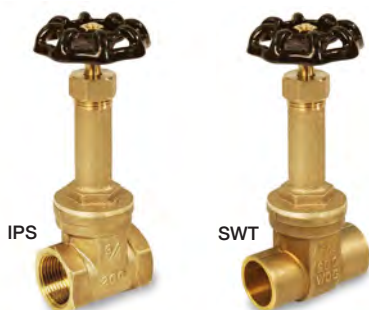

- Cast Brass
- Long Bonnet Allows Ease of Access
- 200 PSI WOG
- Threaded Ends Comply with ANSI B2.1
- Sweat Ends Conform to ASME B16.18
- Conforms to NSF/ANSI-61/ 372 Standards
- Temperature Rating 245°F



THREADED PART #	SWEAT PART #	SIZE	DESCRIPTION	INNER	MASTER
44122-NL	44121-NL	1/2"	Long Bonnet Gate Valve	10	80
44342-NL	44341-NL	3/4"	Long Bonnet Gate Valve	10	60

822 Series Heavy Duty Long Bonnet Gate Valve



Lead Free • Cast Brass Body • 300 WOG

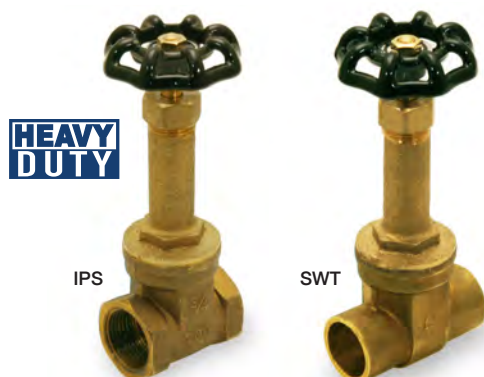

HEAVY DUTY

- Cast Brass
- Long Bonnet Allows Ease of Access
- Rising Stem
- Conforms to Federal Specs MSS-SP80
- Threaded Ends Comply with ANSI B2.1
- Sweat Ends Conform to ASME B16.18
- Conforms to NSF/ANSI-61/ 372 Standards
- 300 WOG - 150 SWP



THREADED PART #	SWEAT PART #	SIZE	DESCRIPTION	INNER	MASTER
822T012-NL	822C012-NL	1/2"	Heavy Duty Long Bonnet Gate Valve	10	80
822T034-NL	822C034-NL	3/4"	Heavy Duty Long Bonnet Gate Valve	10	60

43 Series Long Bonnet Stop Valve



Lead Free • Forged Brass Body • 125 WOG



- Brass Body
- Long Bonnet Allows Ease of Access
- Rising Stem
- Compression Style Stop Valve
- Threaded Ends Comply with ANSI B2.1
- Sweat Ends Conform to ASME B16.18
- Conforms to NSF/ANSI-61/ 372 Standards
- 125 WOG Non Shock
- Temperature Rating 180°F



THREADED PART #	SWEAT PART #	SIZE	DESCRIPTION	INNER	MASTER
43122-NL	43121-NL	1/2"	Long Bonnet Stop Valve	10	100
43342-NL	43341-NL	3/4"	Long Bonnet Stop Valve	10	100

BOILER DRAINS

FIP Boiler Drain w/Stuffing Box



FIP X Hose • 125 WOG • Brass Body



- Brass Body
- Angle Pattern Boiler Drain with Stuffing Box
- CSA and Truesdail Certified
- Lead Free Models Conform to NSF/ANSI 61-8 /372
- Maximum Temperature: 180°F
- ISO:9001 Approved Manufacturer



LEAD FREE PART #	PART #	SIZE	DESCRIPTION	INNER	MASTER
4612F-NL	4612F	1/2"	Boiler Drain	10	100
4634F-NL	4634F	3/4"	Boiler Drain	10	100

MIP Boiler Drain w/Stuffing Box



MIP X Hose • 125 WOG • Brass Body



- Brass Body
- Angle Pattern Boiler Drain with Stuffing Box
- 1/2" Inlet is Dual MIP & Sweat
- Lead Free Models Conform to NSF/ANSI 61-8 /372
- CSA Certified - ASME A112.18.1/CSA B125.1
- Maximum Temperature: 180°F
- ISO:9001 Approved Manufacturer



LEAD FREE PART #	PART #	SIZE	DESCRIPTION	INNER	MASTER
4612-NL	4612	1/2"	Boiler Drain	10	100
4634-NL	4634	3/4"	Boiler Drain	10	100

PEX Boiler Drain w/Stuffing Box



FIP X Hose • 125 WOG • Brass Body

ACTIV
F1807
CRIMP PEX



- Brass Body
- Angle Pattern Boiler Drain with Stuffing Box
- CSA and Truesdail Certified
- Lead Free Models Conform to NSF/ANSI 61-8 /372
- Maximum Temperature: 180°F
- ISO:9001 Approved Manufacturer



LEAD FREE PART #	SIZE	DESCRIPTION	INNER	MASTER
4612P-NL	1/2"	Boiler Drain	10	100
4634P-NL	3/4"	Boiler Drain	10	100

1/4 Turn Boiler Drain



MIP X Hose • Brass Body



- Brass Body
- Chrome Plated Brass Ball
- Quarter Turn Butterfly style aluminum T-handle
- Lead Free Models Conform to NSF/ANSI 61-8 /372
- Conforms to ASME A112.18.1-2011
- Pressure Rating is 125 PSI
- Temperature Rating 160°F



LEAD FREE PART #	PART #	SIZE	DESCRIPTION	INNER	MASTER
46122-NL	46122	1/2"	1/4 Turn Boiler Drain	10	100
46342-NL	46342	3/4"	1/4 Turn Boiler Drain	10	100

1/4 Turn Boiler Drain

RAVEN
SPECIALTY PRODUCTS

High Temperature • Ceramic Disc • MIP X Hose • Brass Body



- Brass Body
- 45° Angle Prevents Hose Kinking
- 300 PSI 32° - 300°F
- Ceramic Disc Allow for High Temperatures
- Extended Threads on Bib Spout for Secure Connection
- Low Operating Torque
- Lead Free Meets NSF-61 Standard



LEAD FREE PART #	SIZE	DESCRIPTION	INNER	MASTER
12CCBD-NL	1/2"	1/4 Turn Boiler Drain	5	60
34CCBD-NL	3/4"	1/4 Turn Boiler Drain	5	60

BOILER DRAINS

RAVEN
 SPECIALTY PRODUCTS

Hose Bibs / Boiler Drains

Lead Free • Forged Brass Body

- 45° Angle Prevents Hose Kinking
- Adjustable Stem Packing Gland
- 125 PSI at 32° to 200°F
- Forged Brass
- Low Operating Torque
- Lead Free Meets NSF-61 Standard
- Leaded Meets ANSI/NSF 14 Standard
- Extended Threads on Bib Spout for Secure Connection

Press T-Handle Boiler Drain



LEAD FREE PART #	SIZE	INNER	MASTER
12BDBTR-NL	1/2"	10	100
34BDBTR-NL	3/4"	10	100



Lever Handle Brass Boiler Drain



LEAD FREE PART #	SIZE	INNER	MASTER
12BDBL-NL	1/2"	10	100
34BDBL-NL	3/4"	5	50

T-Handle Brass Boiler Drain



LEAD FREE PART #	PART #	SIZE	INNER	MASTER
12BDBT-NL	12BDBT	1/2"	10	100
34BDBT-NL	34BDBT	3/4"	5	50

Lever Handle Chrome Plated Boiler Drain



LEAD FREE PART #	PART #	SIZE	INNER	MASTER
12BDCL-NL		1/2"	10	100
34BDCL-NL	34BDCL	3/4"	5	50

T-Handle Chrome Plated Boiler Drain



LEAD FREE PART #	SIZE	INNER	MASTER
12BDCT-NL	1/2"	10	100
34BDCT-NL	3/4"	5	50

Loose Key Brass Boiler Drain w/ Cap



LEAD FREE PART #	SIZE	INNER	MASTER
R1670	1/2"	10	100

T-Handle Long Body Boiler Drain



LEAD FREE PART #	SIZE	INNER	MASTER
12LBBD-NL	1/2"	10	100
34LBBD-NL	3/4"	5	50

Loose Key Chrome Boiler Drain w/ Cap



LEAD FREE PART #	SIZE	INNER	MASTER
R1671	1/2"	10	100

Street End Boiler Drain

- New Design with Dimensions of Our Acclaimed 1/4 Turn Boiler Drain
- Street Ends Enable Sweating Valve Directly into Wrot Fitting
- Offers a Nice Clean Look When Installed



Extended Street For Press Connections

LEAD FREE PART #	SIZE	INNER	MASTER
12BDSX-NL	1/2" Male Swt	10	100
34BDSX-NL	3/4" Male Swt	5	50



Street End Lever

LEAD FREE PART #	SIZE	INNER	MASTER
12BDBT#2-NL	1/2" Male Swt	10	100



Long Body Street End

LEAD FREE PART #	SIZE	INNER	MASTER
12BDBTLB-NL	1/2" Male Swt	10	100
34BDBTLB-NL	3/4" Male Swt	5	50

HOSE BIBS & SILLCOCKS

1/4 Turn Hose Bib



MIP X Hose • Aluminum Handle



- Cast Brass Body
- NSF/ANSI 372 Compliant
- Conforms to AMSE A112.18/CSA B125
- Pressure Rating 125 PSI
- Maximum Temperature: 200°F
- Manufactured in an ISO-9002 compliant facility



LEAD FREE PART #	PART #	SIZE	DESCRIPTION	INNER	MASTER
46121-NL	46121	1/2"	MIP/SWT Hose Bib	10	100
46341-NL	46341	3/4"	MIP/FIP Hose bib	10	100

1/4 Turn No Kink Hose Bib



MIP X Hose • Brass Body



- Brass Body
- Chrome Plated Brass Ball
- Butterfly style aluminum T-handle
- Conforms to ASME A112.18.1-2011
- Conforms to NSF 61-G
- Pressure rating is 125 PSI
- Temperature rating is 160°F



LEAD FREE PART #	PART #	SIZE	DESCRIPTION	INNER	MASTER
46123-NL	46123	1/2"	No Kink Hose Bib	10	100
46343-NL	46343	3/4"	No Kink Hose Bib	10	100

1/4 Turn No Kink Hose Bib



MIP X Hose • Brass Body



- Brass Body
- Butterfly style aluminum T-handle
- NSF/ANSI 372 Compliant
- Compliant to ASME A112.18.1-2011/CSA B125.1-11
- Pressure rating is 125 PSI WWP Non Shock
- Temperature rating is 200°F



LEAD FREE PART #	SIZE	DESCRIPTION	INNER	MASTER
46124-NL	1/2"	MIP/SWT X Plain End 1/4 Turn	10	100

Multi-Turn Sillcock



MIP X Hose • Brass Body



- Cast Brass Body
- Multi Turn Sillcock with Stuffing Box
- Turn Wheel Handle
- Complies with NSF/ANSI 372-2011
- Conforms to ASME A112.18.5/CSA B125.1
- Pressure rating is 125 PSI WWP Non Shock
- Temperature rating is 180°F



LEAD FREE PART #	PART #	SIZE	DESCRIPTION	INNER	MASTER
4712-NL	4712	1/2"	IPS Sillcock	10	100
4734-NL	4734	3/4"	IPS Sillcock	10	100
4722-NL	4722	1/2"	SWT Sillcock	10	100

1/4 Turn Sillcock



MIP X Hose • Brass Body



- Brass Body
- Chrome Plated Brass Ball
- Aluminum T-handle
- NSF/ANSI 372 Compliant
- Complies with ASME A112.18.1-2011/CSA B125.1-11



LEAD FREE PART #	PART #	SIZE	DESCRIPTION	INNER	MASTER
47122-NL	47122	1/2"	1/4 Turn IPS Sillcock	10	100
47342-NL	47342	3/4"	1/4 Turn IPS Sillcock	10	100
47122P-NL		1/2"	1/4 Turn Pex Sillcock	10	100
47342P-NL		3/4"	1/4 Turn Pex Sillcock	10	100

Ceramic Cartridge Sillcock

RAVEN
SPECIALTY PRODUCTS

1/4 Turn • Rough Brass •



- Rough Brass
- 1/4 Turn Wheel Handle Design
- Ceramic Cartridge



LEAD FREE PART #	PART #	SIZE	DESCRIPTION	INNER	MASTER
1167IPS-NL	1167-IPS	1/2"	IPS Sillcock	10	100
1168IPS-NL	1168-IPS	3/4"	IPS Sillcock	10	100
1167C-NL	1167-C	1/2"	SWT Sillcock	10	100



Chrome Plated Lever Handle Sillcock

Oversized Flange • 1/4 Turn On/Off • High Grade Corrosion Resistant Material



- Available in Threaded, Sweat, Pex F1807 & Pex F1960
- Design for Multi Purpose Outdoor and Indoor Installations
- High Grade Construction Provides Added Resistance to Corrosion
- Stainless Steel Handle & Nuts
- Suitable For a Full Range of Liquids
- Adjustable Stem Sacking Gland
- Extended Bib Threads for Secure Connection
- Oversized Flange for Added Protection and Ease of Installation
- Easy Grip Lever Handle Provides Quick 1/4 Turn On/Off Operation
- Operating Temp 33°F - 300°F
- Max. Operating Pressure 360 PSI
- Patented Item
- Lead Free Models Conform to NSF/ANSI-61/372



IPS

SWT



PEX F1960

PEX F1807

LEAD FREE PART #	PART #	SIZE	DESCRIPTION	INNER	MASTER
1165-IPS-NL	1165-IPS	1/2"	IPS Chrome Plated Sillcock	10	100
1166-IPS-NL	1166-IPS	3/4"	IPS Chrome Plated Sillcock	5	100
1165-C-NL	1165-C	1/2"	SWT Chrome Plated Sillcock	10	100
1166-C-NL	1166-C	3/4"	SWT Chrome Plated Sillcock	5	100
1165WIR-NL	1165-WIR	1/2"	Pex F1960	10	50
1165PEX-NL		1/2"	Pex F1807	10	50

Chrome Plated Sillcock SPECIFICATIONS

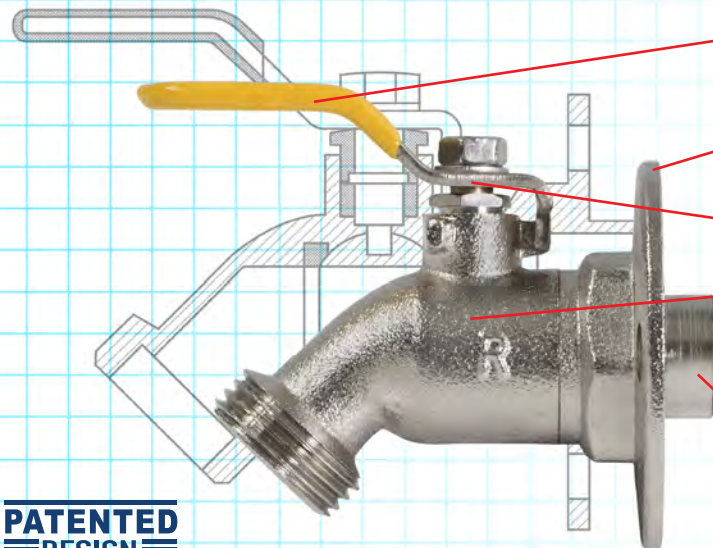

- Easy Grip Lever Handle For Quick On/Off Operation
- Extra Wide Flange For Added Surface Coverage & Protection
- Stainless Steel Handle & Nut
- High Grade Corrosion Resistant Material Provides A Longer Lasting Protection For A Variety Outdoor & Indoor Applications
- Available in Threaded, Sweat, Pex F1807 & Pex F1960

PATENTED
DESIGN

FROST FREE SILLCOCKS



Multi Turn Frost Free Sillcock

3/4" Hose x 1/2" • Available In MIP/SWT, F1807 PEX & F1960 PEX Ends



- Durable Chrome-Plated Body Offers Superior Corrosion Resistance
- Extended-Hub Handwheel Allows for Easy On/Off Operation
- Includes Tapered Sill Wedge, for Easier Installation at Proper Angle
- NL Models Certified to Meet Federal Lead Free Requirements
- Cold Working Pressure 125 PSI
- Truesdale Labs Certified to ANSI/NSF Standard 61-9/372
- MIP/SWT Ends Conform to ANSI / ASME B1.20.1, ANSI / ASME B16.18
- Crimp Pex Ends Conform to ASTM F1807
- Expansion Pex Ends Conform to ASTM F1960
- ISO:9001 Approved Manufacturer
- Replacement Cartridge and Handle Available



MIP/SWT Frost Free Sillcock



LEAD FREE PART #	PART #	SIZE	DESCRIPTION	INNER	MASTER
6204-NL	6204	4"	MIP/SWT Chrome Plated Hose Bib	2	40
6206-NL	6206	6"	MIP/SWT Chrome Plated Hose Bib	2	40
6208-NL	6208	8"	MIP/SWT Chrome Plated Hose Bib	2	40
6210-NL	6210	10"	MIP/SWT Chrome Plated Hose Bib	2	40
6212-NL	6212	12"	MIP/SWT Chrome Plated Hose Bib	2	40
6214-NL	6214	14"	MIP/SWT Chrome Plated Hose Bib	2	40



F1807 Pex Frost Free Sillcock



LEAD FREE PART #	SIZE	DESCRIPTION	INNER	MASTER
6204P-NL	4"	F1807 Pex Chrome Plated Hose Bib	2	40
6206P-NL	6"	F1807 Pex Chrome Plated Hose Bib	2	40
6208P-NL	8"	F1807 Pex Chrome Plated Hose Bib	2	40
6210P-NL	10"	F1807 Pex Chrome Plated Hose Bib	2	40
6212P-NL	12"	F1807 Pex Chrome Plated Hose Bib	2	40
6214P-NL	14"	F1807 Pex Chrome Plated Hose Bib	2	40



F1960 Pex Frost Free Sillcock



LEAD FREE PART #	SIZE	DESCRIPTION	INNER	MASTER
6204F-NL	4"	F1960 Pex Chrome Plated Hose Bib	2	40
6206F-NL	6"	F1960 Pex Chrome Plated Hose Bib	2	40
6208F-NL	8"	F1960 Pex Chrome Plated Hose Bib	2	40
6210F-NL	10"	F1960 Pex Chrome Plated Hose Bib	2	40
6212F-NL	12"	F1960 Pex Chrome Plated Hose Bib	2	40
6214F-NL	14"	F1960 Pex Chrome Plated Hose Bib	2	40

Replacement Handle



PART #
62HANDLE

Replacement Cartridge



PART #
6204CAR 4" 6206CAR 6" 6208CAR 8" 6210CAR 10" 6212CAR 12" 6214CAR 14"

FROST FREE SILLCOCKS

Multi Turn Frost Free Sillcock with Vacuum Breaker



3/4" Hose x 1/2" • Available In MIP/SWT, F1807 PEX & F1960 PEX Ends



- Anti-Siphon Vacuum Breaker and Internal Check Valve, Prevent Backflow
- Durable Chrome-Plated Body Offers Superior Corrosion Resistance
- Extended-Hub Handwheel Allows for Easy On/Off Operation
- Includes Tapered Sill Wedge, for Easier Installation at Proper Angle
- Certified to A.S.S.E. Standard 1019, Type A
- NL Models Certified to Meet Federal Lead Free Requirements
- Cold Working Pressure 125 PSI
- Truesdale Labs Certified to ANSI/NSF Standard 61-9/372
- CSA Certified
- MIP/SWT Ends Conform to ANSI / ASME B1.20.1, ANSI / ASME B16.18
- Crimp Pex Ends Conform to ASTM F1807
- Expansion Pex Ends Conform to ASTM F1960
- ISO:9001 Approved Manufacturer
- Replacement Cartridge, Handle and Cap Available

MIP/SWT Frost Free Sillcock



LEAD FREE PART #	PART #	SIZE	DESCRIPTION	INNER	MASTER
62041-NL		4"	MIP/SWT Chrome Plated Hose Bib	2	40
62061-NL	62061	6"	MIP/SWT Chrome Plated Hose Bib	2	40
62081-NL	62081	8"	MIP/SWT Chrome Plated Hose Bib	2	40
62101-NL	62101	10"	MIP/SWT Chrome Plated Hose Bib	2	40
62121-NL	62121	12"	MIP/SWT Chrome Plated Hose Bib	2	40



F1807 Pex Frost Free Sillcock



LEAD FREE PART #	SIZE	DESCRIPTION	INNER	MASTER
62041P-NL	4"	F1807 Pex Chrome Plated Hose Bib	2	40
62061P-NL	6"	F1807 Pex Chrome Plated Hose Bib	2	40
62081P-NL	8"	F1807 Pex Chrome Plated Hose Bib	2	40
62101P-NL	10"	F1807 Pex Chrome Plated Hose Bib	2	40
62121P-NL	12"	F1807 Pex Chrome Plated Hose Bib	2	40



F1960 Pex Frost Free Sillcock



LEAD FREE PART #	SIZE	DESCRIPTION	INNER	MASTER
62041F-NL	4"	F1960 Pex Chrome Plated Hose Bib	2	40
62061F-NL	6"	F1960 Pex Chrome Plated Hose Bib	2	40
62081F-NL	8"	F1960 Pex Chrome Plated Hose Bib	2	40
62101F-NL	10"	F1960 Pex Chrome Plated Hose Bib	2	40
62121F-NL	12"	F1960 Pex Chrome Plated Hose Bib	2	40



Replacement Handle

Replacement Cap



PART #
62HANDLE



PART #
62CAP

Replacement Cartridge



PART #
62041CAR 4" 62061CAR 6" 62081CAR 8" 62101CAR 10" 62121CAR 12" 62141CAR 14"

FROST FREE SILLCOCKS

1/2 Turn Frost Free Sillcock with Vacuum Breaker

RAVEN
SPECIALTY PRODUCTS

3/4" Hose x 1/2" MIP/SWT • Quick 1/2 Turn Shutoff • Ceramic Cartridge



- Integral Backflow Device Protects Up to 125 PSI of Back Pressure
- EPDM Rubber Packing Helps Prevent Leaking Behind Packing Nut
- Will Not Rupture from Freezing When Valve is Shut Off and Hose is Removed
- Full Circle Operating Threads on the Valve Body & Retainer for a Secure Fit
- 1/2 Turn design Allows for Easy On/Off Operation
- ISO:9001 Approved Manufacturer



PART #	SIZE	DESCRIPTION	INNER	MASTER
FP-1132-4C	4"	Chrome Plated Hose Bib	1	24
FP-1132-6C	6"	Chrome Plated Hose Bib	1	24
FP-1132-8C	8"	Chrome Plated Hose Bib	1	24
FP-1132-10C	10"	Chrome Plated Hose Bib	1	24
FP-1132-12C	12"	Chrome Plated Hose Bib	1	24
FP-1132-14C	14"	Chrome Plated Hose Bib	1	24



Sillcock Ceramic Replacement Cartridge

PART #	SIZE	DESCRIPTION	INNER	MASTER
FP-CC-8	8"			
FP-CC-10	10"			
FP-CC-12	12"			
FP-CC-14	14"			

Multi Turn Frost Free Sillcock

RAVEN
SPECIALTY PRODUCTS

3/4" Hose x 1/2" MIP/SWT • Anti-Siphon Protection



- Durable Chrome-Plated Body Offers Superior Corrosion Resistance
- Extended-Hub Handwheel Allows for Easy On/Off Operation
- Includes Tapered Sill Wedge, for Easier Installation at Proper Angle
- NL Models Certified to Meet Federal Lead Free Requirements
- Cold Working Pressure 125 PSI
- Truesdale Labs Certified to ANSI/NSF Standard 61-9/372
- MIP/SWT Ends Conform to ANSI / ASME B1.20.1, ANSI / ASME B16.18
- ISO:9001 Approved Manufacturer



Frost Free Sillcock

LEAD FREE PART #	PART #	SIZE	DESCRIPTION	INNER	MASTER
FP-1142-4-NL	FP-1142-4	1/2" x 4"	Frost Free Sillcock	1	24
FP-1142-6-NL	FP-1142-6	1/2" x 6"	Frost Free Sillcock	1	24
FP-1142-8-NL	FP-1142-8	1/2" x 8"	Frost Free Sillcock	1	24
FP-1142-10-NL	FP-1142-10	1/2" x 10"	Frost Free Sillcock	1	24
FP-1142-12-NL	FP-1142-12	1/2" x 12"	Frost Free Sillcock	1	24
FP-1142-14-NL	FP-1142-14	1/2" x 14"	Frost Free Sillcock	1	24



Frost Free Sillcock w/ Vacuum Breaker



LEAD FREE PART #	PART #	SIZE	DESCRIPTION	INNER	MASTER
FP-1142V-4-NL		1/2" x 4"	Sillcock w/ Vacuum Breaker	1	24
FP-1142V-6-NL	FP-1142V-6	1/2" x 6"	Sillcock w/ Vacuum Breaker	1	24
FP-1142V-8-NL	FP-1142V-8	1/2" x 8"	Sillcock w/ Vacuum Breaker	1	24
FP-1142V-10-NL	FP-1142V-10	1/2" x 10"	Sillcock w/ Vacuum Breaker	1	24
FP-1142V-12-NL	FP-1142V-12	1/2" x 12"	Sillcock w/ Vacuum Breaker	1	24

ACCESSORIES

Hose Bib Vacuum Breaker



Lead Free • Backflow Preventor



- Prevents Water from Siphoning Back Into the Drinking Water System
- Available in Rough Brass and Chrome Finish



LEAD FREE PART #	PART #	SIZE	DESCRIPTION	INNER	MASTER
VB3400-NL	VB3400	3/4"	Rough Brass	20	200
88C-NL		3/4"	Chrome Finish	20	200

Sump Pump Check Valve



Rubber Flexible Couplings



- Stainless Steel Clamps
- ASTM C1173
- For Plastic, Cast Iron or Steel Pipes

PART #	SIZE	DESCRIPTION	INNER	MASTER
SPCV112	1-1/2" X 1-1/4"	Sump Pump Check Valve	1	50
SPCV22	2" X 2"	Sump Pump Check Valve	1	50

Trap Primer

Pressure Drop Activated • EPPM Seals

Routinely delivers potable water to seldom used floor drains. Activates with a 10 psig pressure drop between 25-125 psi. Designed to be installed on a cold water line serving a frequently used fixture.

- Built in Vacuum Breaker Ports
- Threaded Inlet and Outlet Connection
- Lead Free Brass Material
- Maintains Water in the Trap
- Maximum Supply Pressure: 125 psi
- Minimum Supply Pressure Must Exceed 25 psi
- CSA & ASSE Certified
- EPDM Seals



PART #	SIZE	DESCRIPTION	INNER	MASTER
EFTP300T	1/2"	Trap Primer	1	24

Ball Drip Valve



NPT Thread x NPT Thread • Lead Free • Brass Body



- Two Piece
- Solid Brass Ball
- For Horizontal Use Only



PART #	SIZE	DESCRIPTION	INNER	MASTER
681T012-NL	1/2"	Ball Drip Valve	10	100
681T034-NL	3/4"	Ball Drip Valve	10	100

Water Tester Cap & Valve



Jim Cap with Ball Valve •



- Stainless Steel Band & Clamp
- Made from Durable Rubber Material
- Rubber Cap W/ 1/4 Turn Hose Fitting
- Allows for Easy Testing & Draining of System

PART #	SIZE	DESCRIPTION	INNER	MASTER
WTC112	1-1/2"	Water Tester Cap & Valve	1	1
WTC2	2"	Water Tester Cap & Valve	1	1
WTC3	3"	Water Tester Cap & Valve	1	1

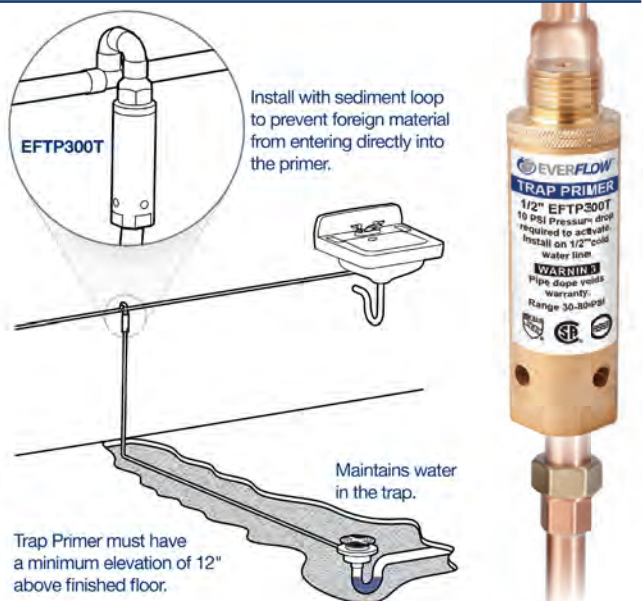

THERMOPLASTIC VALVES

PVC Ball Valve

Threaded Connection • 150 WOG



- ISO 9002, 150 PSI at 73°F
- For use with non-potable water
- With EPDM o-rings and TPE seats, fits schedule 40 or 80 pipe

PART #	SIZE	ENDS	DESCRIPTION	BAG
260T012	1/2"	Threaded	PVC Ball Valve White Economy	162
260T034	3/4"	Threaded	PVC Ball Valve White Economy	80
260T100	1"	Threaded	PVC Ball Valve White Economy	84
260T114	1-1/4"	Threaded	PVC Ball Valve White Economy	50
260T112	1-1/2"	Threaded	PVC Ball Valve White Economy	50
260T200	2"	Threaded	PVC Ball Valve White Economy	24
260T212	2-1/2"	Threaded	PVC Ball Valve White Economy	18
260T300	3"	Threaded	PVC Ball Valve White Economy	2
260T400	4"	Threaded	PVC Ball Valve White Economy	1

PVC Ball Valve

Solvent Connection • 150 WOG



- ISO 9002, 150 PSI at 73°F
- For use with non-potable water
- With EPDM o-rings and TPE seats, fits schedule 40 or 80 pipe

PART #	SIZE	ENDS	DESCRIPTION	BAG
260S012	1/2"	Solvent	PVC Ball Valve White Economy	162
260S034	3/4"	Solvent	PVC Ball Valve White Economy	80
260S100	1"	Solvent	PVC Ball Valve White Economy	84
260S114	1-1/4"	Solvent	PVC Ball Valve White Economy	50
260S112	1-1/2"	Solvent	PVC Ball Valve White Economy	50
260S200	2"	Solvent	PVC Ball Valve White Economy	24
260S212	2-1/2"	Solvent	PVC Ball Valve White Economy	18
260S300	3"	Solvent	PVC Ball Valve White Economy	2
260S400	4"	Solvent	PVC Ball Valve White Economy	1
260S600	6"	Solvent	PVC Ball Valve White Economy	1

PVC Ball Valve NSF Certified

Threaded Connection • 150 WOG



- Pressure rating 150 PSI at 73°F, Max / Min temperature 140°F / 41°F
- NSF Certified to NSF/ANSI 14, 61 & 372
- ISO 9002, ANSI B1.20.1, ASTM F1970
- With EPDM o-rings and TPE seats, fits schedule 40 or 80 pipe



PART #	SIZE	ENDS	DESCRIPTION	BAG
265T012	1/2"	Threaded	PVC Ball Valve White	162
265T034	3/4"	Threaded	PVC Ball Valve White	80
265T100	1"	Threaded	PVC Ball Valve White	84
265T114	1-1/4"	Threaded	PVC Ball Valve White	50
265T112	1-1/2"	Threaded	PVC Ball Valve White	50
265T200	2"	Threaded	PVC Ball Valve White	24
265T212	2-1/2"	Threaded	PVC Ball Valve White	18
265T300	3"	Threaded	PVC Ball Valve White	2
265T400	4"	Threaded	PVC Ball Valve White	1



THERMOPLASTIC VALVES

PVC Ball Valve NSF Certified

Solvent Connection • 150 WOG



- Pressure rating 150 PSI at 73°F, Max / Min temperature 140°F / 41°F
- NSF Certified to NSF/ANSI 14, 61 & 372
- ISO 9002, ASTM F1970
- With EPDM o-rings and TPE seats, fits schedule 40 or 80 pipe



PART #	SIZE	ENDS	DESCRIPTION	BAG
265S012	1/2"	Solvent	PVC Ball Valve White	162
265S034	3/4"	Solvent	PVC Ball Valve White	80
265S100	1"	Solvent	PVC Ball Valve White	84
265S114	1-1/4"	Solvent	PVC Ball Valve White	50
265S112	1-1/2"	Solvent	PVC Ball Valve White	50
265S200	2"	Solvent	PVC Ball Valve White	24
265S212	2-1/2"	Solvent	PVC Ball Valve White	18
265S300	3"	Solvent	PVC Ball Valve White	2
265S400	4"	Solvent	PVC Ball Valve White	1

Gray PVC Ball Valve NSF Certified

Threaded Connection • 150 WOG



- Pressure rating 150 PSI at 73°F, Max / Min temperature 140°F / 41°F
- NSF Certified to NSF/ANSI 14, 61 & 372
- ISO 9002, ANSI B1.20.1, ASTM F1970
- With EPDM o-rings and TPE seats, Ideal for 80 pipe



PART #	SIZE	ENDS	DESCRIPTION	BAG
270T012	1/2"	Threaded	Sch. 80 PVC Ball Valve Gray	162
270T034	3/4"	Threaded	Sch. 80 PVC Ball Valve Gray	80
270T100	1"	Threaded	Sch. 80 PVC Ball Valve Gray	84
270T114	1-1/4"	Threaded	Sch. 80 PVC Ball Valve Gray	50
270T112	1-1/2"	Threaded	Sch. 80 PVC Ball Valve Gray	50
270T200	2"	Threaded	Sch. 80 PVC Ball Valve Gray	24
270T212	2-1/2"	Threaded	Sch. 80 PVC Ball Valve Gray	18
270T300	3"	Threaded	Sch. 80 PVC Ball Valve Gray	2
270T400	4"	Threaded	Sch. 80 PVC Ball Valve Gray	1

Gray PVC Ball Valve NSF Certified

Solvent Connection • 150 WOG



- Pressure rating 150 PSI at 73°F, Max / Min temperature 140°F / 41°F
- NSF Certified to NSF/ANSI 14, 61 & 372
- ISO 9002, ASTM F1970
- With EPDM o-rings and TPE seats, Ideal for 80 pipe



PART #	SIZE	ENDS	DESCRIPTION	BAG
270S012	1/2"	Solvent	Sch. 80 PVC Ball Valve Gray	162
270S034	3/4"	Solvent	Sch. 80 PVC Ball Valve Gray	80
270S100	1"	Solvent	Sch. 80 PVC Ball Valve Gray	84
270S114	1-1/4"	Solvent	Sch. 80 PVC Ball Valve Gray	50
270S112	1-1/2"	Solvent	Sch. 80 PVC Ball Valve Gray	50
270S200	2"	Solvent	Sch. 80 PVC Ball Valve Gray	24
270S212	2-1/2"	Solvent	Sch. 80 PVC Ball Valve Gray	18
270S300	3"	Solvent	Sch. 80 PVC Ball Valve Gray	2
270S400	4"	Solvent	Sch. 80 PVC Ball Valve Gray	1

THERMOPLASTIC VALVES

Gray Half Union PVC Ball Valve



Threaded Connection • 150 WOG



- Thicker walls, reinforced union & stronger valve stem
- Easy installation with hand-tightened union nut
- For use with non-potable water
- Pressure rating 150 PSI at 73°F, Max / Min temperature 140°F / 41°F
- ISO 9002, ANSI B1.20.1, ASTM F1970
- With EPDM o-rings and PTFE seats, fits schedule 40 or 80 pipe

PART #	SIZE	ENDS	DESCRIPTION	BAG
275T012	1/2"	Threaded	PVC Half Union Ball Valve Gray	168
275T034	3/4"	Threaded	PVC Half Union Ball Valve Gray	105
275T100	1"	Threaded	PVC Half Union Ball Valve Gray	84
275T114	1-1/4"	Threaded	PVC Half Union Ball Valve Gray	30
275T112	1-1/2"	Threaded	PVC Half Union Ball Valve Gray	32
275T200	2"	Threaded	PVC Half Union Ball Valve Gray	12
275T212	2-1/2"	Threaded	PVC Half Union Ball Valve Gray	6

Gray Half Union PVC Ball Valve



Solvent Connection • 150 WOG



- Thicker walls, reinforced union & stronger valve stem
- Easy installation with hand-tightened union nut
- For use with non-potable water
- Pressure rating 150 PSI at 73°F, Max / Min temperature 140°F / 41°F
- ISO 9002, ASTM F1970
- With EPDM o-rings and PTFE seats, fits schedule 40 or 80 pipe

PART #	SIZE	ENDS	DESCRIPTION	BAG
275S012	1/2"	Solvent	PVC Half Union Ball Valve Gray	168
275S034	3/4"	Solvent	PVC Half Union Ball Valve Gray	105
275S100	1"	Solvent	PVC Half Union Ball Valve Gray	84
275S114	1-1/4"	Solvent	PVC Half Union Ball Valve Gray	30
275S112	1-1/2"	Solvent	PVC Half Union Ball Valve Gray	32
275S200	2"	Solvent	PVC Half Union Ball Valve Gray	12
275S212	2-1/2"	Solvent	PVC Half Union Ball Valve Gray	6

Gray True Union PVC Ball Valve



Threaded & Solvent Connections Included • Schedule 80 • 150 WOG



- Thicker walls, reinforced union & stronger valve stem
- Easy installation with hand-tightened union nuts
- For use with non-potable water
- Pressure rating 150 PSI at 73°F, Max / Min temperature 140°F / 41°F
- ISO 9002, ANSI B1.20.1, ASTM F1970
- With EPDM o-rings and PTFE seats, fits schedule 40 or 80 pipe

PART #	SIZE	ENDS	DESCRIPTION	BAG
280TS012	1/2"	Threaded / Solvent	PVC True Union Ball Valve Gray	105
280TS034	3/4"	Threaded / Solvent	PVC True Union Ball Valve Gray	72
280TS100	1"	Threaded / Solvent	PVC True Union Ball Valve Gray	32
280TS114	1-1/4"	Threaded / Solvent	PVC True Union Ball Valve Gray	30
280TS112	1-1/2"	Threaded / Solvent	PVC True Union Ball Valve Gray	24
280TS200	2"	Threaded / Solvent	PVC True Union Ball Valve Gray	8
280TS212	2-1/2"	Threaded / Solvent	PVC True Union Ball Valve Gray	5
280TS300	3"	Threaded / Solvent	PVC True Union Ball Valve Gray	2
280TS400	4"	Threaded / Solvent	PVC True Union Ball Valve Gray	2

THERMOPLASTIC VALVES

PVC Half Union Check Valve



Solvent Connection • Spring Check • Gray Color



- Valve can be unassembled for easy maintenance
- Installs horizontally or vertically
- Stainless steel spring loaded ball cone check
- Pressure rating 150 PSI at 73°F, Max / Min temperature 140°F / 41°F
- ISO 9002, ANSI B1.20.1, ASTM F1970
- For use with non-potable water

PART #	SIZE	ENDS	DESCRIPTION	BAG
295S012	1/2"	Solvent	PVC Half Union Check Valve	216
295S034	3/4"	Solvent	PVC Half Union Check Valve	140
295S100	1"	Solvent	PVC Half Union Check Valve	70
295S114	1-1/4"	Solvent	PVC Half Union Check Valve	56
295S112	1-1/2"	Solvent	PVC Half Union Check Valve	56
295S200	2"	Solvent	PVC Half Union Check Valve	24

CPVC Ball Valve NSF Certified



Solvent Connection • Copper Tube Size • Bone Color



- For hot/cold water, approved for use with potable water
- Large port, With PTE Seats
- NSF Listed to NSF 61,372
- ISO 9002, ASTM F1970
- Pressure rating 100 PSI at 180°F, Max temperature 180°F



PART #	SIZE	ENDS	DESCRIPTION	BAG
250S012	1/2"	Solvent	CPVC Ball Valve	160
250S034	3/4"	Solvent	CPVC Ball Valve	80
250S100	1"	Solvent	CPVC Ball Valve	60
250S114	1-1/4"	Solvent	CPVC Ball Valve	37
250S112	1-1/2"	Solvent	CPVC Ball Valve	25
250S200	2"	Solvent	CPVC Ball Valve	15

PVC Check Valve



Threaded Connection • Inline Check



- Installs horizontally or vertically
- Stainless steel spring loaded check
- Cracking pressure @ .5 PSI
- Pressure rating 150 PSI at 73°F, Max / Min temperature 140°F / 41°F
- ISO 9002, ANSI B1.20.1, ASTM F1970
- For use with non-potable water

PART #	SIZE	ENDS	DESCRIPTION	BAG
290T012	1/2"	Threaded	PVC Spring Check Valve	216
290T034	3/4"	Threaded	PVC Spring Check Valve	140
290T100	1"	Threaded	PVC Spring Check Valve	70
290T114	1-1/4"	Threaded	PVC Spring Check Valve	56
290T112	1-1/2"	Threaded	PVC Spring Check Valve	56
290T200	2"	Threaded	PVC Spring Check Valve	24

PVC Check Valve



Solvent Connection • Inline Check



- Installs horizontally or vertically
- Stainless steel spring loaded check
- Cracking pressure @ .5 PSI
- Pressure rating 150 PSI at 73°F, Max / Min temperature 140°F / 41°F
- ISO 9002, ASTM F1970
- For use with non-potable water

PART #	SIZE	ENDS	DESCRIPTION	BAG
290S012	1/2"	Solvent	PVC Spring Check Valve	216
290S034	3/4"	Solvent	PVC Spring Check Valve	140
290S100	1"	Solvent	PVC Spring Check Valve	70
290S114	1-1/4"	Solvent	PVC Spring Check Valve	56
290S112	1-1/2"	Solvent	PVC Spring Check Valve	56
290S200	2"	Solvent	PVC Spring Check Valve	24

THERMOPLASTIC SPECIALTIES

PVC Compression Adapter



Male



- 150 PSI at 73°F
- Conforms to NSF/ANSI 61 & 372



PART #	SIZE	DESCRIPTION	BAG
365CA012	1/2"	Compression Male Adapter	120
365CA034	3/4"	Compression Male Adapter	96
365CA100	1"	Compression Male Adapter	64
365CA114	1-1/4"	Compression Male Adapter	45
365CA112	1-1/2"	Compression Male Adapter	36
365CA200	2"	Compression Male Adapter	24

PVC Compression Tee



Solvent Branch



- 150 PSI at 73°F
- Conforms to NSF/ANSI 61 & 372



PART #	SIZE	DESCRIPTION	BAG
375CT012	1/2"	Compression Tee Solvent Branch	120
375CT034	3/4"	Compression Tee Solvent Branch	96
375CT100	1"	Compression Tee Solvent Branch	64
375CT114	1-1/4"	Compression Tee Solvent Branch	45
375CT112	1-1/2"	Compression Tee Solvent Branch	36
375CT200	2"	Compression Tee Solvent Branch	24

PVC Compression Coupling



- 150 PSI at 73°F
- Conforms to NSF/ANSI 61 & 372



PART #	SIZE	DESCRIPTION	BAG
360CC012	1/2"	Compression Coupling	50
360CC034	3/4"	Compression Coupling	40
360CC100	1"	Compression Coupling	32
360CC114	1-1/4"	Compression Coupling	20
360CC112	1-1/2"	Compression Coupling	16
360CC200	2"	Compression Coupling	18
360CC212	2-1/2"	Compression Coupling	6
360CC300	3"	Compression Coupling	8
360CC400	4"	Compression Coupling	3

PVC Compression Tee



FIP Branch



- 150 PSI at 73°F
- Conforms to NSF/ANSI 61 & 372



PART #	SIZE	DESCRIPTION	BAG
370CT012	1/2"	Compression Tee FIP Branch	50
370CT034	3/4"	Compression Tee FIP Branch	32
370CT3412	3/4" x 1/2"	Compression Tee FIP Branch	32
370CT100	1"	Compression Tee FIP Branch	24
370CT114	1-1/4"	Compression Tee FIP Branch	18
370CT112	1-1/2"	Compression Tee FIP Branch	14
370CT200	2"	Compression Tee FIP Branch	18

PVC Repair Coupling



Expandable Coupling • Heavy PVC Construction



- Union end with double o-ring slider
- Pressure rating 150 PSI at 73°F, complies to ASTM D1784 & D2466
- ISO 9002, ANSI B1.20.1, ASTM F1970
- Conforms to NSF/ANSI 61 & 372, For cold water use only



PART #	SIZE	LENGTH	DESCRIPTION	BAG
345RC012	1/2"	Expands from 6-3/4" to 8-1/2"	PVC Repair Coupling	56
345RC034	3/4"	Expands from 7-1/2" to 9-3/4"	PVC Repair Coupling	32
345RC100	1"	Expands from 8-3/4" to 11-1/4"	PVC Repair Coupling	24
345RC114	1-1/4"	Expands from 9" to 11-3/4"	PVC Repair Coupling	18
345RC112	1-1/2"	Expands from 10" to 13"	PVC Repair Coupling	24
345RC200	2"	Expands from 11-1/4" to 14-1/4"	PVC Repair Coupling	9
345RC212	2-1/2"	Expands from 13" to 17-1/4"	PVC Repair Coupling	10
345RC300	3"	Expands from 14-3/4" to 18-3/4"	PVC Repair Coupling	6
345RC400	4"	Expands from 15" to 18-1/4"	PVC Repair Coupling	3

THERMOPLASTIC SPECIALTIES

PVC Union



Threaded



- 150 PSI at 73°F
- NSF Listed to NSF 14 & 61

PART #	SIZE	DESCRIPTION	BAG
390CU012	1/2"	Threaded Union White	120
390CU034	3/4"	Threaded Union White	96
390CU100	1"	Threaded Union White	64
390CU114	1-1/4"	Threaded Union White	45
390CU112	1-1/2"	Threaded Union White	36
390CU200	2"	Threaded Union White	24

Gray PVC Union



Sch. 80 Threaded



- 150 PSI at 73°F
- Conforms to NSF/ANSI 61 & 372

PART #	SIZE	DESCRIPTION	BAG
380CU012	1/2"	PVC Union Sch. 80 Threaded Gray	96
380CU034	3/4"	PVC Union Sch. 80 Threaded Gray	54
380CU100	1"	PVC Union Sch. 80 Threaded Gray	36
380CU114	1-1/4"	PVC Union Sch. 80 Threaded Gray	36
380CU112	1-1/2"	PVC Union Sch. 80 Threaded Gray	20
380CU200	2"	PVC Union Sch. 80 Threaded Gray	16

PVC Union



Solvent



- 150 PSI at 73°F
- NSF Listed to NSF 14 & 61

PART #	SIZE	DESCRIPTION	BAG
395CU012	1/2"	Solvent Union White	288
395CU034	3/4"	Solvent Union White	240
395CU100	1"	Solvent Union White	123
395CU114	1-1/4"	Solvent Union White	72
395CU112	1-1/2"	Solvent Union White	45
395CU200	2"	Solvent Union White	24
395CU212	2-1/2"	Solvent Union White	16
395CU300	3"	Solvent Union White	12
395CU400	4"	Solvent Union White	8

Gray PVC Union



Sch. 80 Solvent



- 150 PSI at 73°F
- Conforms to NSF/ANSI 61 & 372

PART #	SIZE	DESCRIPTION	BAG
385CU012	1/2"	PVC Union Sch. 80 Solvent Gray	96
385CU034	3/4"	PVC Union Sch. 80 Solvent Gray	54
385CU100	1"	PVC Union Sch. 80 Solvent Gray	36
385CU114	1-1/4"	PVC Union Sch. 80 Solvent Gray	36
385CU112	1-1/2"	PVC Union Sch. 80 Solvent Gray	20
385CU200	2"	PVC Union Sch. 80 Solvent Gray	16

CPVC Union



Solvent



- For hot/cold water
- For use with potable water
- 100 PSI at 180°F
- NSF Listed to NSF 14 & 61

PART #	SIZE	DESCRIPTION	BAG
355S012	1/2"	CPVC Union	330
355S034	3/4"	CPVC Union	120



Press Forward.

EXCLUSIVE Product

PRESS
CONNECT

new innovation



WATER SUPPLY STOP VALVES



1/4 Turn Press Supply Stops

Double-O-Ring • Lead Free • 1/4 Turn Ball Valve Design • Chrome Plated Brass Body

- One-piece Chrome Plated Brass Body Provides Strength, Durability and Long-Lasting Performance
- Oval Chrome Plated Zinc Handle Provides a Secure Grip and Smooth On/Off Operation
- Easy-to-Remove Handle with Screw Attachment
- Self Lubricating PTFE Seats and Double O-Ring for Added Safety
- 100 psi, Normal Working Temperature 120°F
- Conforms to NSF/ANSI 61/372
- Individually Boxed and Barcoded



LEAD FREE



1/4 Turn Press Angle Stop



PART #	END TYPE	SIZE / DESCRIPTION	INNER	MASTER
P-81214PR-NL	PRESS	1/2" PRESS X 1/4" OD	12	144
P-81212PR-NL	PRESS	1/2" PRESS X 3/8" OD	12	144



1/4 Turn Press Straight Stop



PART #	END TYPE	SIZE / DESCRIPTION	INNER	MASTER
P-82214PR-NL	PRESS	1/2" PRESS X 1/4" OD	12	144
P-82212PR-NL	PRESS	1/2" PRESS X 3/8" OD	12	144



1/4 Turn Press Dual Angle Stop



PART #	END TYPE	SIZE / DESCRIPTION	INNER	MASTER
P-86312PR-NL	PRESS	1/2" PRESS X 3/8" OD x 3/8" OD	12	144
P-86324PR-NL	PRESS	1/2" PRESS X 1/4" OD x 3/8" OD	12	144

PRESS STOP SPECIFICATIONS

- Easy-to-Remove Handle
- Double O-Ring
- Chrome Plated Brass Body

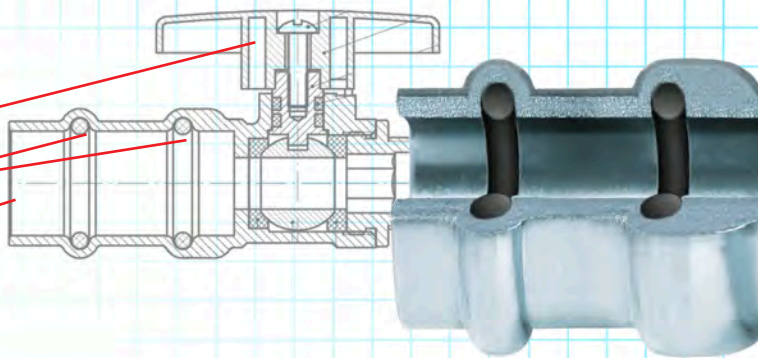

WATER SUPPLY STOP VALVES

Multi Turn Supply Stops

Lead Free • Multi Turn On / Off Design • One-piece Chrome Plated Brass Body

- One-Piece Chrome Plated Brass Body Provides Strength, Durability and Long-Lasting Performance
- Oval Chrome Plated Zinc Handle Provides a Secure Grip and Smooth On/Off Operation
- Easy-to-Remove Handle with Screw Attachment
- Lead Free Compliant
- 125 psi, Max Temperature 160°F
- Conforms to ASME A112.18.1-2011, NSF / ANSI 61 /372
- Individually Bagged and Barcoded

Available in:

FIP/ SWT/ COMP/ CPVC/ PEX F1807



Multi Turn Angle Stop



PART #	END TYPE	SIZE / DESCRIPTION	INNER	MASTER
71114PR-NL	FIP	1/2" FIP x 1/4" OD COMP	10	200
71138PR-NL	FIP	3/8" FIP x 3/8" OD COMP	10	200
71112PR-NL	FIP	1/2" FIP x 3/8" OD COMP	10	200
71214PR-NL	SWEAT	1/2" SWT x 1/4" OD COMP	10	200
71212PR-NL	SWEAT	1/2" SWT x 3/8" OD COMP	10	200
71514PR-NL	COMP	5/8" OD COMP x 1/4" OD COMP	10	200
71358PR-NL	COMP	5/8" OD COMP x 3/8" OD COMP	12	144
71412PR-NL	CPVC	1/2" CPVC x 3/8" OD COMP	10	200
71512PR-NL	PEX F1807	1/2" PEX x 3/8" OD COMP	10	200



Multi Turn Straight Stop



PART #	END TYPE	SIZE / DESCRIPTION	INNER	MASTER
72112PR-NL	FIP	1/2" FIP x 3/8" OD COMP	10	200
72138PR-NL	FIP	3/8" FIP x 3/8" OD COMP	10	200
72212PR-NL	SWEAT	1/2" SWT x 3/8" OD COMP	10	200
72358PR-NL	COMP	5/8" OD COMP x 3/8" OD COMP	10	200
72412PR-NL	CPVC	1/2" CPVC x 3/8" OD COMP	10	200
72512PR-NL	PEX F1807	1/2" PEX 3/8" OD COMP	10	200



Multi Turn Stop W/5" Extension Tube



PART #	END TYPE	SIZE / DESCRIPTION	INNER	MASTER
73212PR-NL	SWEAT	1/2" SWT x 3/8" COMP Angle Stop	10	100
74212PR-NL	SWEAT	1/2" SWT x 3/8" COMP Straight Stop	10	100



Multi Turn Dual Outlet Stop



PART #	END TYPE	SIZE / DESCRIPTION	INNER	MASTER
76358PR-NL	COMP	5/8" x 3/8" x 3/8" COMP	10	100

WATER SUPPLY STOP VALVES



1/4 Turn Supply Stops

Lead Free • 1/4 Turn Ball Valve Design • Chrome Plated Brass Body

- One-piece Chrome Plated Brass Body Provides Strength, Durability and Long-Lasting Performance
- Oval Chrome Plated Zinc Handle Provides a Secure Grip and Smooth On/Off Operation
- Easy-to-Remove Handle with Screw Attachment
- Self Lubricating PTFE Seats and Double O-Ring for Added Safety
- 100 psi, Normal Working Temperature 120°F
- Conforms to NSF/ANSI 61/372
- CSA & Truesdale Certified
- Individually Boxed and Barcoded

Available in:

FIP/ SWT/ COMP/ CPVC/ PEX F1807 & PEX F1960



1/4 Turn Angle Stop



PART #	END TYPE	SIZE / DESCRIPTION	INNER	MASTER
81112PR-NL	FIP	1/2" FIP x 3/8" OD COMP	12	144
81114PR-NL	FIP	1/2" FIP x 1/4" OD COMP	12	144
81138PR-NL	FIP	3/8" FIP x 3/8" OD COMP	12	144
81212PR-NL	SWEAT	1/2" SWT x 3/8" OD COMP	12	144
81214PR-NL	SWEAT	1/2" SWT x 1/4" OD COMP	12	144
81358PR-NL	COMP	5/8" OD COMP x 3/8" OD COMP	12	144
81514PR-NL	COMP	5/8" OD COMP x 1/4" OD COMP	12	144
81412PR-NL	CPVC	1/2" CPVC x 3/8" OD COMP	12	144
81512PR-NL	PEX F1807	1/2" PEX 3/8" OD COMP	12	144
81515PR-NL	PEX F1807	1/2" PEX 1/4" OD COMP	12	144
F-81512PR-NL	PEX F1960	1/2" F1960 x 3/8" COMP	12	144



1/4 Turn Straight Stop



PART #	END TYPE	SIZE / DESCRIPTION	INNER	MASTER
82112PR-NL	FIP	1/2" FIP x 3/8" OD COMP	12	144
82138PR-NL	FIP	3/8" FIP x 3/8" OD COMP	12	144
82212PR-NL	SWEAT	1/2" SWT x 3/8" OD COMP	12	144
82358PR-NL	COMP	5/8" OD COMP x 3/8" OD COMP	12	144
82412PR-NL	CPVC	1/2" CPVC x 3/8" OD COMP	12	144
82512PR-NL	F1807 PEX	1/2" PEX 3/8" OD COMP	12	144
82515PR-NL	F1807 PEX	1/2" PEX 1/4" OD COMP	12	144
F-82512PR-NL	F1960 PEX	1/2" F1960 x 3/8" COMP	12	144



1/4 Turn Dual Outlet Stop



PART #	SIZE	DESCRIPTION	INNER	MASTER
86314PR-NL	FIP	1/2" FIP x 3/8" Comp x 1/4" Comp	10	100
86311PR-NL	FIP	1/2" FIP x 3/8" Comp x 3/8" Comp	10	80
86324PR-NL	SWT	1/2" SWT X 3/8" Comp X 1/4" Comp	5	50
86312PR-NL	SWT	1/2" SWT X 3/8" Comp X 3/8" Comp	5	40
86358PR-NL	COMP	5/8" Comp x 3/8" Comp x 3/8" Comp	5	30
86351PR-NL	PEX	1/2" PEX x 3/8" Comp x 3/8" Comp	2	20

WATER SUPPLY STOP VALVES

1/4 Turn Supply Stops continued



Lead Free • 1/4 Turn Ball Valve Design • Chrome Plated Brass Body



1/4 Turn Stop W/5" Extension Tube



PART #	END TYPE	SIZE / DESCRIPTION	INNER	MASTER
83212PR-NL	SWEAT	1/2" SWT x 3/8" COMP Angle Stop	10	100
84212PR-NL	SWEAT	1/2" SWT x 3/8" COMP Straight Stop	10	100



1/4 Turn Loose Key Angle Stop



PART #	END TYPE	SIZE / DESCRIPTION	INNER	MASTER
91112PR-NL	FIP	1/2" FIP x 3/8" OD COMP	12	144
91212PR-NL	SWEAT	1/2" SWT x 3/8" COMP	12	144
91358PR-NL	COMP	5/8" OD COMP x 3/8" OD COMP	12	144



1/4 Turn Loose Key Straight Stop



PART #	END TYPE	SIZE / DESCRIPTION	INNER	MASTER
92112PR-NL	FIP	1/2" FIP x 3/8" OD COMP	12	144
92212PR-NL	SWEAT	1/2" SWT x 3/8" COMP	12	144
92358PR-NL	COMP	5/8" OD COMP x 3/8" OD COMP	12	144
93212PR-NL	SWEAT	1/2" SWT x 3/8" COMP	25	100



FIP x MIP Add On Valve



PART #	END TYPE	SIZE / DESCRIPTION	INNER	MASTER
82314PR-NL	COMP	3/8" COMP FEM X 1/4" COMP Male	12	144
82338PR-NL	COMP	3/8" COMP FEM X 3/8" COMP Male	12	144

Easy Connect Supply Stop Tee

Lead Free • Brass Construction



Easy Connect Tee



PART #	END TYPE	SIZE / DESCRIPTION	INNER	MASTER
73314-NL	COMP	3/8" FEM COMP x 3/8" MALE x 1/4" MALE	12	144
73338-NL	COMP	3/8" FEM COMP x 3/8" MALE x 3/8" MALE	12	144

Full Line of Needle Valves available. See our Brass Specialty products section of our catalog.



WATER SUPPLY STOP VALVES

RAVEN
SPECIALTY PRODUCTS

1/4 Turn Supply Stop Valves

Lead Free • 1/4 Turn Ball Valve Design • Chrome Plated Brass Body

- One-Piece Chrome Plated Brass Body Provides Strength, Durability and Long-Lasting Performance
- Oval Chrome Plated Zinc Handle Provides a Secure Grip and Smooth On/Off Operation
- Easy-to-Remove Handle with Screw Attachment
- Self Lubricating PTFE Seats and Double O-Ring for Added Safety
- 100 psi, Normal Working Temperature 120°F
- Conforms to NSF/ANSI 61/372
- Individually Boxed and Barcoded

Available in:

FIP/ SWT/ COMP/ CPVC/ PEX F1807 & PEX F1960



1/4 Turn Angle Stop



PART #	END TYPE	SIZE / DESCRIPTION	INNER	MASTER
27-CA14-NL	COMP	1/4" COMP x 3/8" COMP	12	144
27-CA58-NL	COMP	5/8" COMP X 3/8" COMP	12	144
27-CPA12-NL	CPVC	1/2" CPVC X 3/8" COMP	12	144
27-PA1214-NL	F1807 PEX	1/2" PEX 1/4" COMP	12	144
27-PA12-NL	F1807 PEX	1/2" PEX 3/8" COMP	12	144



1/4 Turn Straight Stop



PART #	END TYPE	SIZE / DESCRIPTION	INNER	MASTER
27-CS14-NL	COMP	1/4" COMP x 3/8" COMP	12	144
27-CS58-NL	COMP	5/8" COMP X 3/8" COMP	12	144
27-CPS12-NL	CPVC	1/2" CPVC X 3/8" COMP	12	144
27-PS1214-NL	F1807 PEX	1/2" PEX 1/4" COMP	12	144
27-PS12-NL	F1807 PEX	1/2" PEX 3/8" COMP	12	144



1/4 Turn Stop W/5" Extension Tube



PART #	END TYPE	SIZE / DESCRIPTION	INNER	MASTER
27-ESS12-NL	COMP	1/2" SWT X 3/8" COMP Staright	12	144
27-ESA12-NL	COMP	1/2" SWT X 3/8" COMP Angle	12	144



1/4 Turn Loose Key Angle Stop



PART #	END TYPE	SIZE / DESCRIPTION	INNER	MASTER
27-KPA12-NL	F1807 PEX	1/2" PEX X 3/8" COMP	20	240
27-KSA12-NL	SWEAT	1/2" SWT x 3/8" COMP	20	240
27-KCA58-NL	COMP	5/8" COMP x 3/8" COMP	20	240

WATER SUPPLY STOP VALVES

1/4 Turn Supply Stop Valves continued

RAVEN
SPECIALTY PRODUCTS

Lead Free • 1/4 Turn Ball Valve Design • Chrome Plated Brass Body



1/4 Turn Loose Key Straight Stop



PART #	END TYPE	SIZE / DESCRIPTION	INNER	MASTER
27-KPS12-NL	F1807 PEX	1/2" PEX X 3/8" COMP	20	240
27-KSS12-NL	SWEAT	1/2" SWT x 3/8" COMP	20	240
27-KCS58-NL	COMP	5/8" COMP x 3/8" COMP	20	240



F1960 Pex Water Supply Stop



PART #	END TYPE	SIZE / DESCRIPTION	INNER	MASTER
27-WA1214-NL	F1960 PEX	1/2" F1960 x 1/4" Comp Angle	10	100
27-WA12-NL	F1960 PEX	1/2" F1960 x 3/8" Comp Angle	10	100
27-WS12-NL	F1960 PEX	1/2" F1960 x 3/8" Comp Staright	10	100



Fix-A-Valve Water Supply Stop



PART #	END TYPE	SIZE / DESCRIPTION	INNER	MASTER
27-FS38-NL	FIP	3/8" FIP X 3/8" MALE	12	144

Push-Fit Supply Stop Valves



Lead Free • 1/4 Turn Ball Valve Design • Chrome Finish

- Chrome Plated brass Body Provides Strength, Durability and Long-Lasting Performance
- Metal Handle
- Slim Fitting Design
- 200 PSI WOG



CONNECTS TO



Push Fit 1/4 Turn Angle Stop



PART #	END TYPE	SIZE / DESCRIPTION	INNER	MASTER
UPASC1214	Push X Comp	1/2" Push x 1/4" Comp	5	30
UPASC1238	Push X Comp	1/2" Push x 3/8" Comp	5	30
UPASP1212	Push X Push	1/2" Push x 1/2" Push	5	30



Push Fit 1/4 Turn Straight Stop



PART #	END TYPE	SIZE / DESCRIPTION	INNER	MASTER
UPSSC1214	Push X Comp	1/2" Push x 1/4" Comp	5	30
UPSSC1238	Push X Comp	1/2" Push x 3/8" Comp	5	30
UPSSP1212	Push X Push	1/2" Push x 1/2" Push	5	30

SPECIALTY SUPPLY VALVES

Dual Washing Machine Valve

RAVEN
SPECIALTY PRODUCTS

Ball Style



- Cast Brass Construction
- For Use with Washing Machine Shut Off
- Single On/Off Lever Controls Hot & Cold Water Simultaneously

PART #	SIZE / DESCRIPTION	INNER	MASTER
WMV12	1/2" Sweat X 3/4" Hose	1	24

Pex Drop Ear Ice Maker Valve

RAVEN
SPECIALTY PRODUCTS

Ball Style Dishwasher Valve



- 1/4 Turn
- Lead Free
- Compatible with F1807 PEX and F1960 PEX
- Drop Ears for Secure Mounting

PART #	SIZE / DESCRIPTION	INNER	MASTER
WIMV12-NL	1/2" F1960 PEX x 1/4" Comp	10	100
PIMV12-NL	1/2" F1807 PEX x 1/4" Comp	10	100

Ice Maker/Humidifier Valve

RAVEN
SPECIALTY PRODUCTS

Comp x Comp Ice Maker Valve



- 1/4 Turn
- Lead Free
- Connect Ice Maker to 1/2" copper pipe

PART #	SIZE / DESCRIPTION	INNER	MASTER
IMV58-NL	5/8" comp / 1/2" Sweat end x 1/4" Comp	10	100
IMV78-NL	7/8" comp / 3/4" Sweat end x 1/4" Comp	10	100
IMV38	3/8" comp / 1/4" Sweat end x 1/4" Comp	10	100

Dishwasher Valve

RAVEN
SPECIALTY PRODUCTS

Ball Style Dishwasher Valve



- 1/4 Turn
- Lead Free
- Connect Dishwasher to 1/2" & 3/8" Copper Pipe

PART #	SIZE / DESCRIPTION	INNER	MASTER
DWV38-NL	5/8" comp / 1/2" Sweat end x 3/8" Comp	1	1

Brass Anti-Sweat Valve

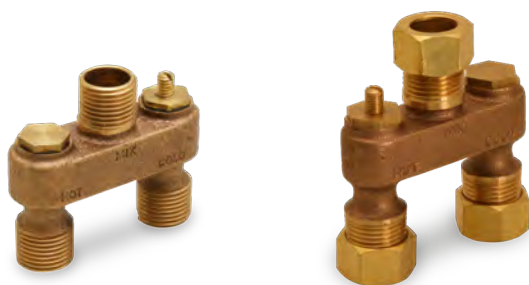
RAVEN
SPECIALTY PRODUCTS

PART #	SIZE / DESCRIPTION	INNER	MASTER
R1290	1/2" Brass Anti-Sweat Valve	1	36
R1291	1/2" Brass Anti-Sweat Valve w/ Nuts	1	24

Chrome Plated Anti-Sweat Valve

RAVEN
SPECIALTY PRODUCTS

PART #	SIZE / DESCRIPTION	INNER	MASTER
R1293	1/2" Chrome Plated Anti-Sweat Valve	10	50
R1292	1/2" Chrome Plated Anti-Sweat Valve w/ Nuts	1	36

Anti-Sweat Valve Repair Kit

PART #	SIZE / DESCRIPTION	INNER	MASTER
R1296	Anti-Sweat Valve Repair Kit	1	1

ACCESSORIES

Water Meter Flange Kit



Lead Free Bronze Oval

- 2 Flanges & Gaskets
- 4 Nuts & Bolts
- Forged Bronze
- Oval Design



PART #	SIZE	DESCRIPTION	INNER	MASTER
WMFS112K-NL	1-1/2"	SWT Flange Kit	1	12
WMFS200K-NL	2"	SWT Flange Kit	1	10
WMFT112K-NL	1-1/2"	IPS Flange Kit	1	12
WMFT200K-NL	2"	IPS Flange Kit	1	10

Gasket For Water Meter Flange Set

PART #	SIZE	DESCRIPTION	INNER	MASTER
WMFG112	1-1/2"	2 Gaskets	1	1
WMFG002	2"	2 Gaskets	1	1

Water Meter Flange

PART #	SIZE	DESCRIPTION	INNER	MASTER
WMFS112-NL	1-1/2"	SWT Water Meter Flange	4	32
WMFS200-NL	2"	SWT Water Meter Flange	6	24
WMFT112-NL	1-1/2"	IPS Water Meter Flange	4	32
WMFT200-NL	2"	IPS Water Meter Flange	6	24

Water Meter Flange Nuts & Bolts

PART #	DESCRIPTION	INNER	MASTER
WMFN1000	Pack of 4 Nuts & Bolts	5	20
WMFN2000	pack of 4 Stainless Steel Nuts & Bolts	5	20

F x F x C EZ Long x Water Tee



- 3/4" Long Female End Threads Directly Into Cold Water Inlet of Water Heater



PART #	SIZE	DESCRIPTION	INNER	MASTER
R1396-NL	3/4" F Long x 1/2" F x 1/2" C	Tee	10	60
R1397-NL	3/4" F Long x 1/2" F x 3/4" C	Tee	10	60

M x F x C EZ Long x Water Tee



- 1/2" or 3/4" Female End Receives Vacuum Relief Valve and 1/2" or 3/4" C Branch to Connect Cold Water Supply



PART #	SIZE	DESCRIPTION	INNER	MASTER
R1394-NL	3/4" M Long x 1/2" F x 1/2" C	Tee	10	60
R1395-NL	3/4" M Long x 1/2" F x 3/4" C	Tee	10	60

Male Long x SWT Adapter



- Connects Hot Water Outlet to 1/2" or 3/4" Copper Pipe
- Takes the Place of Fitting & Nipple Assembly



PART #	SIZE	DESCRIPTION	INNER	MASTER
R1398-NL	3/4" M Long x 1/2" C	Adapter	10	60
R1399-NL	3/4" M Long x 3/4" C	Adapter	10	60

PEX Water Meter Coupling



Lead Free • With Washer



F1960 PART #	F1807 PART #	SIZE	INNER	MASTER
WMW0012-NL	WMP0012-NL	1/2" PEX x 3/4" FIP	20	160
WMW0034-NL	WMP0034-NL	3/4" PEX x 1" FIP	20	100
WMW1011-NL	WMP1011-NL	1" PEX x 1-1/4" FIP	10	80

Brass Water Meter Coupling



Lead Free • With Washer



- Brass Nipple & Nut with Rubber Gasket

PART #	SIZE	DESCRIPTION	INNER	MASTER
WMC0012-NL	1/2" MIP X 3/4" FIP	Water Meter Coupling	20	160
WMC0034-NL	3/4" MIP X 1" FIP	Water Meter Coupling	20	100
WMC1011-NL	1" MIP X 1-1/4" FIP	Water Meter Coupling	10	80
WMC1520-NL	1-1/2" MIP X 2" FIP	Water Meter Coupling	2	24
WMC2025-NL	2" MIP X 2-1/2" FIP	Water Meter Coupling	2	24

Water Service Straight Coupling



Lead Free Compliant • Flare x MIP

- Bronze Construction
- Conforms to A.W.W.A.
- Male Pipe Thread to Flare Copper



PART #	SIZE	DESCRIPTION	INNER	MASTER
WS-AFM0034	3/4" FLARE X MIP	Straight Coupling	10	100
WS-AFM0100	1" FLARE X MIP	Straight Coupling	6	60
WS-AFM0112	1-1/2" FLARE X MIP	Straight Coupling	2	24
WS-AFM0200	2" FLARE X MIP	Straight Coupling	1	12

Water Service 1/4 Bend Elbow



Lead Free • Flare x MIP

- Bronze Construction
- Conforms to A.W.W.A.
- Male Pipe Thread to Flare Copper



PART #	SIZE	DESCRIPTION	INNER	MASTER
WS-EFM0034	3/4" FLARE X MIP	L Coupling	4	40
WS-EFM0100	1" FLARE X MIP	L Coupling	3	30
WS-EFM0112	1-1/2" FLARE X MIP	L Coupling	1	10
WS-EFM0200	2" FLARE X MIP	L Coupling	1	6

Made with Lubrizol licensed FlowGuard Gold CPVC compound. Product manufacturing design, materials & production, all meet or exceed industry standards. IAPMO listed, meeting cUPC, ANSI/NSF/61 and AB1953 standards. Manufactured in ISO 9001 approved facilities.



PEX x CPVC Socket Adapter

F1807 & F1960 · Lead Free Brass

- Durable Over Molded One-Piece
- Pressure Rating 100 PSI at 180°F
- Pressure Rating 150 PSI at 100°F



F1807 PART #	F1960 PART #	SIZE	DESCRIPTION	INNER	MASTER
BRCPPF012-NL	BRCPEF012-NL	1/2"	Adapter	50	500
BRCPPF034-NL	BRCPEF034-NL	3/4"	Adapter	25	250
BRCPPF100-NL	BRCPEF100-NL	1"	Adapter	20	120
BRCPPF3401-NL		3/4 x 1"	Adapter	20	120

Male x CPVC Adapter

Lead Free Brass

- Durable Over Molded One-Piece
- Pressure Rating 100 PSI at 180°F
- Pressure Rating 150 PSI at 100°F



PART #	SIZE	DESCRIPTION	INNER	MASTER
BRCPM012-NL	1/2"	Adapter	16	384
BRCPM034-NL	3/4"	Adapter	8	240
BRCPM100-NL	1"	Adapter	6	150
BRCPM114-NL	1 1/4"	Adapter	4	40
BRCPM112-NL	1 1/2"	Adapter	4	40
BRCPM200-NL	2"	Adapter	6	30

Female x CPVC Adapter

Lead Free Brass

- Durable Over Molded One-Piece
- Pressure Rating 100 PSI at 180°F
- Pressure Rating 150 PSI at 100°F



PART #	SIZE	DESCRIPTION	INNER	MASTER
BRCPF012-NL	1/2"	Adapter	16	384
BRCPF034-NL	3/4"	Adapter	8	240
BRCPF100-NL	1"	Adapter	6	150
BRCPF114-NL	1 1/4"	Adapter	7	70
BRCPF112-NL	1 1/2"	Adapter	7	70
BRCPF200-NL	2"	Adapter	6	30

CPVC Drop Ear Elbow

Lead Free Brass

- Durable Over Molded One-Piece
- Pressure Rating 100 PSI at 180°F
- Pressure Rating 150 PSI at 100°F



PART #	SIZE	DESCRIPTION	INNER	MASTER
BRCPD012-NL	1/2"	Adapter	50	200

PEX x CPVC Spigot Adapter

F1807 · Lead Free Stainless Steel

- Durable Over Molded One-Piece
- Pressure Rating 100 PSI at 180°F
- Pressure Rating 150 PSI at 100°F



F1807 PART #	SIZE	DESCRIPTION	INNER	MASTER
SSCPPF012-NL	1/2"	Adapter	50	500
SSCPPF034-NL	3/4"	Adapter	25	250

Male x CPVC Adapter

Lead Free Stainless Steel

- Durable Over Molded One-Piece
- Pressure Rating 100 PSI at 180°F
- Pressure Rating 150 PSI at 100°F



PART #	SIZE	DESCRIPTION	INNER	MASTER
SSCPM012-NL	1/2"	Adapter	40	400
SSCPM034-NL	3/4"	Adapter	30	300
SSCPM100-NL	1"	Adapter	20	120
SSCPM114-NL	1 1/4"	Adapter	10	60
SSCPM112-NL	1 1/2"	Adapter	10	40
SSCPM200-NL	2"	Adapter	8	32

Female x CPVC Adapter

Lead Free Stainless Steel

- Durable Over Molded One-Piece
- Pressure Rating 100 PSI at 180°F
- Pressure Rating 150 PSI at 100°F



PART #	SIZE	DESCRIPTION	INNER	MASTER
SSCPF012-NL	1/2"	Adapter	40	400
SSCPF034-NL	3/4"	Adapter	30	300
SSCPF100-NL	1"	Adapter	20	120
SSCPF114-NL	1 1/4"	Adapter	10	60
SSCPF112-NL	1 1/2"	Adapter	10	40
SSCPF200-NL	2"	Adapter	8	32

CPVC Drop Ear Elbow

Lead Free Stainless Steel

- Durable Over Molded One-Piece
- Pressure Rating 100 PSI at 180°F
- Pressure Rating 150 PSI at 100°F



PART #	SIZE	DESCRIPTION	INNER	MASTER
SSCPD012-NL	1/2"	Plastic Ear Adapter	20	200
SSDP012-NL	1/2"	Steel Ear Adapter	20	200
SSDP034-NL	3/4"	Steel Ear Adapter	25	100

DIELECTRIC UNIONS & NIPPLES

Dielectric Unions



Lead Free • ISO 9001

- Lead Free
- Meets ASTM F492-95
- Rated Up to 230°F

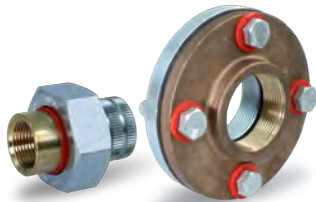

Female x Female Dielectric Unions



PART #	SIZE	DESCRIPTION	INNER	MASTER
DUFF0012-NL	1/2"	Union	15	120
DUFF0034-NL	3/4"	Union	12	96
DUFF0100-NL	1"	Union	6	48
DUFF0114-NL	1-1/4"	Union	6	36
DUFF0112-NL	1-1/2"	Union	4	24
DUFF0200-NL	2"	Union	3	18
DUFF0212-NL	2-1/2" Flanged	Union	1	4
DUFF0300-NL	3" Flanged	Union	1	4
DUFF0400-NL	4" Flanged	Union	1	2

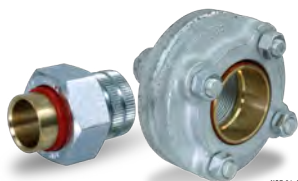

Female x SWT Dielectric Unions



PART #	SIZE	DESCRIPTION	INNER	MASTER
DUFS0012-NL	1/2"	Union	12	144
DUFS0034-NL	3/4"	Union	15	120
DUFS3412-NL	3/4" X 1/2"	Union	15	120
DUFS0100-NL	1"	Union	12	72
DUFS0114-NL	1-1/4"	Union	6	48
DUFS0112-NL	1-1/2"	Union	6	36
DUFS0200-NL	2"	Union	3	18
DUFS0212-NL	2-1/2" Flanged	Union	1	4
DUFS0300-NL	3" Flanged	Union	1	4



Male x SWT Dielectric Unions



PART #	SIZE	DESCRIPTION	INNER	MASTER
DUMS0012-NL	1/2"	Union	12	96
DUMS0034-NL	3/4"	Union	12	72
DUMS3412-NL	3/4" X 1/2"	Union	12	72

Dielectric Nipples



Lead Free • ISO 9001

- 300 PSI
- Rated Up to 230° F
- ASTM A53, ANSI B1.20.1 & ASTM F492-95
- Galvanized Dielectric Nipples
- Pex Liner
- Metal to Metal Design



Thread x Thread Dielectric Nipples



PART #	SIZE	DESCRIPTION	INNER	MASTER
DNTT3425	3/4" X 2-1/2"	Nipples	25	300
DNTT3430	3/4" X 3"	Nipples	25	200
DNTT3440	3/4" X 4"	Nipples	25	200
DNTT1025	1" X 2-1/2"	Nipples	25	100
DNTT1030	1" X 3"	Nipples	25	100
DNTT1040	1" X 4"	Nipples	25	100
DNTT1140	1-1/4" X 4"	Nipples	25	100
DNTT1540	1-1/2" X 4"	Nipples	25	50
DNTT2040	2" X 4"	Nipples	1	40
DNTT2560	2-1/2" X 6"	Nipples	1	20
DNTT3060	3" X 6"	Nipples	1	10
DNTT4060	4" X 6"	Nipples	1	8

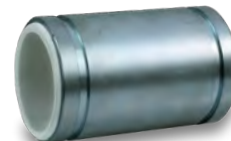

Grooved x Grooved Dielectric Nipples



PART #	SIZE	DESCRIPTION	INNER	MASTER
DNGG2040	2" X 4"	Nipples	1	1
DNGG2560	2-1/2" X 6"	Nipples	1	1
DNGG3060	3" X 6"	Nipples	1	10
DNGG4060	4" X 6"	Nipples	1	1



Threaded x Grooved Dielectric Nipples



PART #	SIZE	DESCRIPTION	INNER	MASTER
DNTG2040	2" X 4"	Nipples	1	40
DNTG2560	2-1/2" X 6"	Nipples	1	20
DNTG3060	3" X 6"	Nipples	1	10
DNTG4060	4" X 6"	Nipples	1	8

METER BARS & ACCESSORIES

Meter Bars



Side-Inlet-Top-Outlet

Meter Bars - Keyspan®



PART #	LENGTH	INLET	OUTLET	SWIVEL	FINISH
GSTB6111	6"	1"	1"	1"	Black
GSTB6121	6-1/2"	1"	1"	1"	Black
GSTB7114	7"	1-1/4"	1-1/4"	1-1/4"	Black
GSTG6111	6"	1"	1"	1"	Galv.
GSTG6121	6-1/2"	1"	1"	1"	Galv.
GSTG7114	7"	1-1/4"	1-1/4"	1-1/4"	Galv.

Side-Inlet-Outlet

Meter Bars



PART #	LENGTH	INLET	OUTLET	SWIVEL	FINISH
GSSB6111	6"	1"	1"	1"	Black
GSSB8141 Con Edison®	8-1/4"	1"	1-1/4"	1-1/4"	Black
GSSG6111	6"	1"	1"	1"	Galv.
GSSG8141 Con Edison®	8-1/4"	1"	1-1/4"	1-1/4"	Galv.

Ball Valve

Meter Bars - Con Edison® Con Edison®



PART #	LENGTH	INLET	OUTLET	SWIVEL	FINISH
GBVB6111	6"	1"	1"	1"	Black
GBVG6111	6"	1"	1"	1"	Galv.

S-Inlet S-Outlet

Meter Bars - Keyspan®



PART #	LENGTH	INLET	OUTLET	SWIVEL	FINISH
GSSG-KS-6111	6"	1"	1"	1"	Galv.
GSSG-KS-7114	7"	1-1/4"	1-1/4"	1-1/4"	Galv.

Meter Plugs

With Tap



PART #	SIZE	LT.	FINISH
GMPT1201	1"	20	Black
GMPT1143	1-1/4"	30	Black

Offset Swivels



PART #	SIZE	LT.	FINISH
GOFB1205	1/2"	5	Black
GOFB3410	3/4"	10	Black
GOFB1201	1"	20	Black
GOFB1143	1-1/4"	30	Black
GOFG3410	3/4"	10	Galv.
GOFG1201	1"	20	Galv.
GOFG1143	1-1/4"	30	Galv.

Nuts for Gas Meters



PART #	SIZE	LT.	FINISH
GMNB1205	1/2"	5	Black
GMNB3410	3/4"	10	Black
GMNB1200	1"	20	Black
GMNB1143	1-1/4"	30	Black
GMNG3410	3/4"	10	Galv.
GMNG1200	1"	20	Galv.
GMNG1143	1-1/4"	30	Galv.

Straight Swivels

For Gas Meter Bars



PART #	SIZE	LT.	FINISH
GSTB3410	3/4"	10	Black
GSTB1200	1"	20	Black
GSTB1143	1-1/4"	30	Black
GSTG3410	3/4"	10	Galv.
GSTG1200	1"	20	Galv.
GSTG1143	1-1/4"	30	Galv.

Gas Regulator Vents

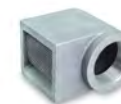

PART #	DESCRIPTION
GGRV3400	3/4" With screen
GGRV1000	1" With Screen
GGRV0114	1-1/4" With Screen
GGRV0112	1-1/2" With Screen

Support Bracket

For Meter Bars & Risers



PART #	DESCRIPTION
GMBS3420	"A" Bracket for meter bar

RAVEN™

GAUGES & THERMOMETERS



THERMOMETERS & GAUGES

Industrial Thermometer

RAVEN
SPECIALTY PRODUCTS

- Accuracy: 1%
- Adjustable Angle
- Aluminum Stem
- Plastic Case
- Glass Window
- Organic Liquid Filled Tube



PART #	SIZE / DESCRIPTION	INNER	MASTER
RG40-9H	9" Hot Water Thermometer 3-1/2" Stem 30-240°F	1	25
RG40-9C	9" Cold Water Thermometer 3-1/2" Stem 0-120°F	1	25



PART #	SIZE / DESCRIPTION	INNER	MASTER
RG40-WS	3-1/2" Brass Well W/Rubber Gasket	6	50
RG40-WE	3-1/2" Brass Extended Well W/Rubber Gasket	6	50

Hot Water Thermometer

RAVEN
SPECIALTY PRODUCTS

- Accuracy: 1%
- Available in Brass or Steel Thermowell
- Available in Straight or Angle Stem
- Painted Steel Body
- Temperature Range 40°-280°F
- 1/2" NPT Mount
- Organic Liquid Filled Tube



PART #	SIZE / DESCRIPTION	INNER	MASTER
RG45-AS	Steel Well, Angle 1/2" NPT 40-280°F	1	50
RG45-AB	Brass Well, Angle 1/2" NPT 40-280°F	1	50
RG45-SS	Steel Well, Straight 1/2" NPT 40-280°F	1	50
RG45-SB	Brass Well, Straight 1/2" NPT 40-280°F	1	50

Hot Water Thermometer

RAVEN
SPECIALTY PRODUCTS

- Accuracy: 1%
- 2-1/2" Display with Steel Zinc Plated Case
- Available in IPS & SWT Well
- Glass Window
- Lead Free Compliant Wells



PART #	SIZE / DESCRIPTION	INNER	MASTER
LFRAVWHT	Thermometer W/ IPS Well	1	100
LFRAVWHTC	Thermometer W/ SWEAT Well	1	100
LFRAVWHTIPS	Thermometer W/ IPS & SWEAT Well	1	50

Hot Water Thermometer Wells

PART #	SIZE / DESCRIPTION	INNER	MASTER
LFWELL-IPS	IPS Well	1	100
LFWELL-COPPER	SWEAT Well	1	100

Strap-On Thermometer

RAVEN
SPECIALTY PRODUCTS

- Accuracy: 1%
- Stainless Steel Spring
- Glass Window
- 2-1/2" Display



PART #	SIZE / DESCRIPTION	INNER	MASTER
SORAVWHT-1	30°-250° F	1	100

E-Z Trailtometer Boiler Gauge

RAVEN
SPECIALTY PRODUCTS

- Temperature Range 30°-250°F
- Connection 1/4" NPT
- Dual Scale Temperature & Pressure Gauge Display



PART #	SIZE / DESCRIPTION	INNER	MASTER
EZTRISTD	Short Shank 1/4" NPT 0-60 PSI Gauge	6	50
EZTRILONG	Long Shank 1/4" NPT 0-60 PSI Gauge	6	50
EZTRISTD2	Short Shank 1/4" NPT 0-200 PSI Gauge	6	50

3" Pressure & Temperature Gauge

RAVEN
SPECIALTY PRODUCTS

- Bottom Entry
- Black Enamel Steel case
- 1/2" Lead Free Brass NPT
- Pressure Range 0-200 PSI
- Dual Pressure Scale PSI & kPa
- Dual Temperature °F & °C measurements



PART #	SIZE / DESCRIPTION	INNER	MASTER
RGPT-200	0-200 PSI Gauge	1	20

PRESSURE GAUGES & TEST GAUGES

Utility Gauges

- Accuracy: 3-2-3%
- 1/4" NPT Male Threaded Mount
- Black Steel Case and Ring
- Internal Brass Parts
- Polycarbonate Lens



RAVEN
SPECIALTY PRODUCTS

2" Display Utility Gauges

PART #	SIZE / DESCRIPTION	INNER	MASTER
PG230	0-30 PSI Gauge	1	100
PG260	0-60 PSI Gauge	1	100
PG2100	0-100 PSI Gauge	1	100
PG2160	0-160 PSI Gauge	1	100
PG2200	0-200 PSI Gauge	1	100
PG2300	0-300 PSI Gauge	1	100

2-1/2" Display Utility Gauges

PART #	SIZE / DESCRIPTION	INNER	MASTER
PG15	0-15 PSI Gauge	1	100
PG30	0-30 PSI Gauge	1	100
PG60	0-60 PSI Gauge	1	100
PG100	0-100 PSI Gauge	1	100
PG160	0-160 PSI Gauge	1	100
PG200	0-200 PSI Gauge	1	100
PG300	0-300 PSI Gauge	1	100
PG60B	0-60 PSI Gauge w/ Back Connection	1	100
PG200B	0-200 PSI Gauge w/ Back Connection	1	100

3-1/2" Display Utility Gauges

PART #	SIZE / DESCRIPTION	INNER	MASTER
PG3515	0-15 PSI Gauge	1	50
PG3530	0-30 PSI Gauge	1	50
PG3560	0-60 PSI Gauge	1	50
PG35100	0-100 PSI Gauge	1	50
PG35160	0-160 PSI Gauge	1	50
PG35200	0-200 PSI Gauge	1	50
PG35300	0-300 PSI Gauge	1	50

4-1/2" Display Utility Gauges

PART #	SIZE / DESCRIPTION	INNER	MASTER
PG4515	0-15 PSI Gauge	1	20
PG4530	0-30 PSI Gauge	1	20
PG4560	0-60 PSI Gauge	1	20
PG45100	0-100 PSI Gauge	1	20
PG45160	0-160 PSI Gauge	1	20
PG45200	0-200 PSI Gauge	1	20
PG45300	0-300 PSI Gauge	1	20
PG45400	0-400 PSI Gauge	1	20
PG45500	0-500 PSI Gauge	1	20

Liquid Filled Gauges

- Accuracy: 3-2-3%
- Glycerin Filled Circular Dial
- Available in 2-1/2" & 4" Display
- Stainless Steel Case
- Internal Brass Parts
- Tempered Glass Lens



RAVEN
SPECIALTY PRODUCTS

PART #	SIZE / DESCRIPTION	INNER	MASTER
PG2.515	0-15 PSI Gauge w/ 2-1/2" Display	1	50
PG2.530	0-30 PSI Gauge w/ 2-1/2" Display	1	50
PG2.560	0-60 PSI Gauge w/ 2-1/2" Display	1	50
PG2.5100	0-100 PSI Gauge w/ 2-1/2" Display	1	50
PG2.5160	0-160 PSI Gauge w/ 2-1/2" Display	1	50
PG2.5200	0-200 PSI Gauge w/ 2-1/2" Display	1	50
PG2.5300	0-300 PSI Gauge w/ 2-1/2" Display	1	50
PGL4100	0-200 PSI Gauge w/ 4" Display	1	20
PGL4300	0-300 PSI Gauge w/ 4" Display	1	20

Water Test Gauge

- 2-1/2" Display
- Steel Case
- Internal Brass Parts
- Polycarbonate Lens
- Swivel Brass Hose Connection



RAVEN
SPECIALTY PRODUCTS

PART #	SIZE / DESCRIPTION	INNER	MASTER
RG66-300	0-300 PSI Gauge	1	50
RG66-301	0-300 PSI Gauge W/ Red Pointer	1	50

Gas Test Gauge

- Accuracy: 3-2-3%
- 2" Display
- Black Steel Case and Ring
- Internal Brass Parts
- Polycarbonate Lens
- Black Painted Iron Bell



RAVEN
SPECIALTY PRODUCTS

PART #	SIZE / DESCRIPTION	INNER	MASTER
RG60-3415	15 PSI, 3/4" NPT Bell Reducer	1	50
RG60-3430	30 PSI, 3/4" NPT Bell Reducer	1	50
RG60-3460	60 PSI, 3/4" NPT Bell Reducer	1	50
RG60-34100	100 PSI, 3/4" NPT Bell Reducer	1	50
RG60-1015	15 PSI, 1" NPT Bell Reducer	1	50
RG60-1030	30 PSI, 1" NPT Bell Reducer	1	50
RG60-1060	60 PSI, 1" NPT Bell Reducer	1	50
RG60-10100	100 PSI, 1" NPT Bell Reducer	1	50

TESTER GAUGES & KITS

Gas Tester & Pressure Kit

RAVEN
SPECIALTY PRODUCTS

- 3 - 1818 MxF Ball Valve Shut Off
- Ball & Barbed Adapter
- Bulb & Hose Assembly
- Includes Heavy Duty Case
- Snifter Valve
- 3/4" M x 1/2" F x 1/8" F x 1/4" F x 1/4" F Double Test Tee



PART #	SIZE / DESCRIPTION	INNER	MASTER
GPTK-5	5 PSI & 160 PSI Gauge Combo Kit	1	10
GPTK	7 PSI & 160 PSI Gauge Combo Kit	1	10

Pressure Test Kit

RAVEN
SPECIALTY PRODUCTS

- Test Tee
- Snifter Valve
- Swivel Hose Connector
- 160 PSI Gauge



PART #	SIZE / DESCRIPTION	INNER	MASTER
PTK	0-160 PSI Gauge kit	1	40

Gas & Pressure Test Kit Parts

RAVEN
SPECIALTY PRODUCTS



PART #	SIZE / DESCRIPTION	INNER	MASTER
Gauges			
GTG-5	5 PSI Gauge	1	50
GTG-7	7 PSI Gauge	1	50

Test Tees

TSTT	3/4" M x 1/2" F x 1/8" F x 1/4" F	1	50
PTT	3/4" M x 1/2" F x 1/8" F x 1/4" F x 1/4" F	1	50

Bulb & Hose Assembly

BHA	For GPTK & GTK	1	100
-----	----------------	---	-----

Gas Tester Kit

RAVEN
SPECIALTY PRODUCTS

- 1818 MxF Ball Valve Shut Off
- Ball & Barbed Adapter
- Bulb & Hose Assembly
- Includes Heavy Duty Case
- Snifter Valve
- 3/4" N x 1/2" F x 1/8" f x 1/4" f Long Body Tee



PART #	SIZE / DESCRIPTION	INNER	MASTER
GTK-5	5 PSI Gauge Kit	1	10
GTK	7 PSI Gauge Kit	1	10

Low Pressure Gas Tester

- 2" Display w/ Steel Case and Ring
- Yellow Zinc Plated Steel Hex Body
- Snifter Valve & Mini Ball Valve



PART #	SIZE / DESCRIPTION	INNER	MASTER
52051	5 PSI Complete Kit w/ Bulb & Hose, Valves & Case	1	10
5205	5 PSI GasTester Hex Body w/ Valves	1	20
5210	10 PSI GasTester Hex Body w/ Valves	1	20

Gas Pressure Tester

RAVEN
SPECIALTY PRODUCTS

- Available in 2" & 4" Display
- Steel Case and Ring
- Internal Brass Parts
- Yellow Zinc Plated Steel Hex Body
- Polycarbonate Lens



PART #	SIZE / DESCRIPTION	INNER	MASTER
5215	15 PSI GasTester 3/4" FIP Hex Body 2" Display	1	50
5230	30 PSI GasTester 3/4" FIP Hex Body 2" Display	1	50
RG52-60	60 PSI GasTester 3/4" FIP Hex Body 2" Display	1	50
RG52-100	100 PSI GasTester 3/4" FIP Hex Body 2" Display	1	50
RG52-160	160 PSI GasTester 3/4" FIP Hex Body 2" Display	1	50
RG52-200	200 PSI GasTester 3/4" FIP Hex Body 2" Display	1	50
RG54-15	15 PSI GasTester 3/4" FIP Hex Body 4" Display	1	50

Gas Pressure Test Parts

RG52-HEX	Yellow Zinc Plated Hex Body	1	100
RG52-SNIFT	Snifter Valve	1	500

RAVEN™
SPECIALTY PRODUCTS

Hydronic Heating Components

High Grade Performance



NOW AVAILABLE
**THERMAL &
HYDRONIC
EXPANSION
TANKS** MADE IN
ITALY



FLEXTRON®

HEATING SPECIALTIES

Feed Pressure Water Regulator

RAVEN
SPECIALTY PRODUCTS

High Capacity • Purge Lever For Manual Purging



- High Capacity
- Tight Seating Check Valve
- Purge Lever for Manual Purging
- Choice of Inlet Connection (Threaded, Union Solder)
- Stainless Steel Strainer to Protect the Valve Disc from Fouling

PART #	SIZE	DESCRIPTION	INNER	MASTER
186TS012	1/2"	Feed Pressure Water Regulator	1	40

Backflow Preventer

RAVEN
SPECIALTY PRODUCTS

High Capacity • Stainless Steel Internal Parts



- True Line Size Construction
- Stainless Steel Internal Parts
- Maximum Flow at Low Pressure Drop
- Install Vertically or Horizontally
- Furnished with Union Connectors to Facilitate Removal

PART #	SIZE	DESCRIPTION	INNER	MASTER
190T012	1/2"	Backflow Preventer	1	60
190T034	3/4"	Backflow Preventer	1	60

Heating Boiler Air Scoop

RAVEN
SPECIALTY PRODUCTS

Cast Iron Construction • Air Eliminator



- One Piece Design
- Engineered Baffle to Separate Air From Water
- Never Requires Servicing
- Cast Iron Construction

PART #	SIZE	DESCRIPTION	INNER	MASTER
ETP-T15-AS34	3/4"	3/4" Air Eliminator	10	60
ETP-T15-AS1	1"	1" Air Eliminator	25	100
ETP-T15-AS114	1 1/4"	1 1/4" Air Eliminator	10	40
ETP-T15-AS112	1 1/2"	1 1/2" Air Eliminator	10	60

Automatic Air Vent

RAVEN
SPECIALTY PRODUCTS

Nickel Plated Brass body



- Perfect for Tight Spaces
- Removes Trapped Air
- For Use on Heating and Air Conditioning Systems

PART #	SIZE	DESCRIPTION	INNER	MASTER
AV-T18	1/8"	Automatic Air Vent	1	68

HEATING SPECIALTIES



Ravent Jr. Spiral Air Eliminator

Micro Bubble Separator • Maintenance Free • Eliminates 99.6% of the Disolved Air



- Simple to Install with a Straight In-Line Design
- Designed for Radiant Heat and Hydronic Systems
- Solid Brass Body Construction for Extended Service Life
- Traps Smallest Microbubbles with Little Resistance
- Spiral Tube Vent Eliminates Air from the System Fluid
- Specially Constructed Air Chamber to Protect the Valve Mechanism from Dirt
- Unique Valve Mechanism is Guaranteed Not to Leak and Cannot be Shut Off
- Standard Thread for Vent Pipe Connection or Pressure Testing
- Vent Head is Designed to Stay Dry
- Male Thread Vent Head Port for Presuure Testing and Remote Venting
- No Venting Required
- Dirt and Leak Resistant
- Quiet Operation
- Available in Threaded & Sweat Connection
- Max Pressure 150 PSI
- Max Temperature 270°F

THREADED PART #	SWEAT PART #	SIZE	DESCRIPTION	INNER	MASTER
RAV-SP034T	RAV-SP034S	3/4"	Spiral Air Eliminator	10	100
RAV-SP001T	RAV-SP001S	1"	Spiral Air Eliminator	10	100
RAV-SP114T	RAV-SP114S	1-1/4"	Spiral Air Eliminator	10	100
RAV-SP112T	RAV-SP112S	1-1/2"	Spiral Air Eliminator	10	80
RAV-SP002T	RAV-SP002S	2"	Spiral Air Eliminator	5	50

Z1000 Series Motorized Zone Valve



2 Way On/Off • Low Voltage



- Brass Body
- Hydronic Control
- Designed for Cycling
- Static Pressure 125 PSI
- EPDM O-Rings

PART #	SIZE	DESCRIPTION	INNER	MASTER
Z1000		Motorized 2-way on-off Zone Valve	1	1
Z1010		Replacement Head for Z1000 Zone Valve	1	1

EXPANSION TANKS

PREMIUM EXPANSION TANKS



HIGH GRADE
STEEL CONSTRUCTION

MADE IN
ITALY

Premium Thermal Expansion Tank **FLEXTRON**

For Water Heaters • Prevent Dangerous Pressure Build Up



HIGH GRADE STEEL CONSTRUCTION

MADE IN
ITALY



- All Tanks are NSF61 Certified
- MIG Welding Eliminates Interior Rough Spots and Sharp Edges
- Durable External Baked Epoxy-Polyester Coating
- Exclusive Polypropylene Liner Eliminates Internal Corrosion
- Protected Precharge Valve Eliminates Potential Leak Path
- Each Tank is Factory Leak Tested
- Operating Pressure 150 PSI, Temperature 210°F



PART #	SIZE	DESCRIPTION	INNER	MASTER
FTT5	2.1 gal	Thermal Expansion Tank	1	1
FTT12	4.8 gal	Thermal Expansion Tank	1	1
FTT18	6.3 gal	Thermal Expansion Tank	1	1

Premium Hydronic Expansion Tank **FLEXTRON**

For Heating Systems • Protect Safety Valves from Failing



HIGH GRADE STEEL CONSTRUCTION

MADE IN
ITALY



- Certified Synthetic SBR Rubber Diaphragm
- MIG Welding Eliminates Interior Rough Spots and Sharp Edges
- Each Tank is Factory Leak Tested
- Durable External Baked Epoxy-Polyester Coating
- Max. Operating Pressure 60 PSI, 2.1 gal 75 PSI
- Operating Temperature 210°F
- Factory Precharge 12 PSI

PART #	SIZE	DESCRIPTION	INNER	MASTER
FTH15	2.1 gal	Hydronic Expansion Tank	1	1
FTH30	4.8 gal	Hydronic Expansion Tank	1	1
FTH60	6.3 gal	Hydronic Expansion Tank	1	1
FTH90	13.2 gal	Hydronic Expansion Tank w/Stand	1	1

E Series Thermal Expansion Tank **FLEXTRON**

For Water Heaters • Prevent Dangerous Pressure Build Up



- All Tanks are NSF61 Certified
- MIG Welding Eliminates Interior Rough Spots and Sharp Edges
- Durable External Baked Epoxy-Polyester Coating
- Exclusive Polypropylene Liner Eliminates Internal Corrosion
- Protected Precharge Valve Eliminates Potential Leak Path
- Each Tank is Factory Leak Tested
- Operating Pressure 150 PSI, Temperature 200°F



PART #	SIZE	DESCRIPTION	INNER	MASTER
E-FTT5	2.1 gal	Thermal Expansion Tank	1	1
E-FTT12	4.8 gal	Thermal Expansion Tank	1	1
E-FTT18	6.3 gal	Thermal Expansion Tank	1	1

E Series Hydronic Expansion Tank **FLEXTRON**

For Heating Systems • Protect Safety Valves from Failing



- EPDM Rubber Diaphragm
- MIG Welding Eliminates Interior Rough Spots and Sharp Edges
- Each Tank is Factory Leak Tested
- Durable External Baked Epoxy-Polyester Coating
- Max. Operating Pressure 150 PSI, 13.2 gal 60 PSI
- Operating Temperature 240°F
- Factory Precharge 12 PSI

PART #	SIZE	DESCRIPTION	INNER	MASTER
FTH15	2.1 gal	Hydronic Expansion Tank	1	1
FTH30	4.8 gal	Hydronic Expansion Tank	1	1
FTH60	6.3 gal	Hydronic Expansion Tank	1	1
FTH90	13.2 gal	Hydronic Expansion Tank w/Stand	1	1

RADIATOR VALVES

Steam Angle Radiator Valve



FIP X Male Union • 15 WSP - 60 WOG



- Brass Body
- Includes Nut and Tailpiece
- Molded Thermal Plastic Handle
- ISO:9001 Approved Manufacturer

PART #	SIZE	DESCRIPTION	INNER	MASTER
48712	1/2"	Angle Steam Radiator Valve	10	60
48342	3/4"	Angle Steam Radiator Valve	8	48
48120	1"	Angle Steam Radiator Valve	6	36
48142	1-1/4"	Angle Steam Radiator Valve	4	24
48112	1-1/2"	Angle Steam Radiator Valve	3	18
48200	2"	Angle Steam Radiator Valve	2	12

Steam Radiator Gate Valve



FIP X Male Union • 125 WSP - 200 WOG



- Brass Body
- Temperature rating 300°F
- Includes Nut and Tailpiece
- Molded Thermal Plastic Handle
- ISO:9001 Approved Manufacturer

PART #	SIZE	DESCRIPTION	INNER	MASTER
48612	1/2"	Steam Radiator Gate Valve	10	60
48341	3/4"	Steam Radiator Gate Valve	8	48
48111	1"	Steam Radiator Gate Valve	6	36
48141	1-1/4"	Steam Radiator Gate Valve	4	24
48121	1-1/2"	Steam Radiator Gate Valve	3	18

Hot Water Angle Radiator Valve



FIP or SWT X Male Union • Heavy Pattern • 15 WSP - 60 WOG



- Brass Body
- Includes Nut and Tailpiece
- Molded Thermal Plastic Handle
- ISO:9001 Approved Manufacturer

THREADED PART #	SWEAT PART #	SIZE	DESCRIPTION	INNER	MASTER
HWV-T012	HWV-S012	1/2"	Radiator Angle Valve	10	80
HWV-T034	HWV-S034	3/4"	Radiator Angle Valve	6	60
HWV-T001	HWV-S001	1"	Radiator Angle Valve	6	36
HWV-T114		1-1/4"	Radiator Angle Valve	4	24

Steam Radiator Converter Valve



Female Union x FIP Connection • 15 WSP 60 WOG



- Brass Body
- Includes Nut and Tailpiece
- Molded Thermal Plastic Handle
- ISO:9001 Approved Manufacturer

PART #	SIZE	DESCRIPTION	INNER	MASTER
48130	1"	Steam Radiator Converter Valve	6	36
48143	1-1/4"	Steam Radiator Converter Valve	4	24

RADIATOR VALVES

Steam Angle Radiator Valve

RAVEN
SPECIALTY PRODUCTS

PTFE Seats • FIP X Male Union • 15 WSP - 60 WOG

**HEAVY
DUTY**



- Heavy Duty Brass Body
- Includes Nut and Tailpiece
- Molded Thermal Plastic Handle
- ISO:9001 Approved Manufacturer

PART #	SIZE	DESCRIPTION	INNER	MASTER
RSA012	1/2"	Angle Steam Radiator Valve	10	60
RSA034	3/4"	Angle Steam Radiator Valve	8	48
RSA001	1"	Angle Steam Radiator Valve	6	36
RSA114	1-1/4"	Angle Steam Radiator Valve	4	24
RSA112	1-1/2"	Angle Steam Radiator Valve	3	18

Steam Radiator Gate Valve

RAVEN
SPECIALTY PRODUCTS

FIP X Male Union • 125 WSP - 200 WOG

**HEAVY
DUTY**



- Heavy Duty Brass Body
- Temperature rating 300°F
- Includes Nut and Tailpiece
- Molded Thermal Plastic Handle
- ISO:9001 Approved Manufacturer

PART #	SIZE	DESCRIPTION	INNER	MASTER
RSS034	3/4"	Steam Radiator Gate Valve	8	48
RSS001	1"	Steam Radiator Gate Valve	6	36
RSS114	1-1/4"	Steam Radiator Gate Valve	4	24
RSS112	1-1/2"	Steam Radiator Gate Valve	3	18

Hot Water Angle Radiator Valve

RAVEN
SPECIALTY PRODUCTS

FIP or SWT X Male Union • Heavy Pattern • 15 WSP - 60 WOG

**HEAVY
DUTY**



- Heavy Duty Brass Body
- Includes Nut and Tailpiece
- Molded Thermal Plastic Handle
- ISO:9001 Approved Manufacturer

THREADED PART #	SWEAT PART #	SIZE	DESCRIPTION	INNER	MASTER
RWA012T	RWA012S	1/2"	Radiator Angle Valve	10	80
RWA034T	RWA034S	3/4"	Radiator Angle Valve	6	60
RWA001T	RWA001S	1"	Radiator Angle Valve	6	36

Steam Radiator Convactor Valve

RAVEN
SPECIALTY PRODUCTS

PTFE Seats • Female Union x FIP Connection • 15 WSP 60 WOG

**HEAVY
DUTY**



- Heavy Duty Brass Body
- Includes Nut and Tailpiece
- Molded Thermal Plastic Handle
- ISO:9001 Approved Manufacturer

PART #	SIZE	DESCRIPTION	INNER	MASTER
RSC001	1"	Steam Radiator Convactor Valve	6	36
RSC114	1-1/4"	Steam Radiator Convactor Valve	4	24

HEATING SPECIALTIES

IPS & SWT Union Elbow



Includes Nut & Tailpiece •



- Brass Body
- Available in Sweat and Threaded Ends
- ISO:9001 Approved Manufacturer

THREADED PART #	SWEAT PART #	SIZE	DESCRIPTION	INNER	MASTER
48212	48312	1/2"	Union Elbow	10	150
48234	48334	3/4"	Union Elbow	10	100
4821		1"	Union Elbow	7	70
48214		1-1/4"	Union Elbow	5	50

Sweat Monoflow Tee



Brass Body



- Brass Body
- Used in One Pipe Hot Water Heating Systems
- Supplies Radiators, Convectors, Baseboards & Kick Space Heaters
- ISO:9001 Approved Manufacturer

PART #	SIZE	DESCRIPTION	INNER	MASTER
3412	3/4" X 1/2"	SWT Monoflow Tee	40	160
0112	1" X 1/2"	SWT Monoflow Tee	25	100
0134	1" X 3/4"	SWT Monoflow Tee	25	100
11412	1-1/4" X 1/2"	SWT Monoflow Tee	20	80

Pex Monoflow Tee



Available in Crimp PEX & Expansion Pex

ASTM **F1807**
CRIMP PEX

ASTM **F1960**
EXPANSION PEX



- Crimp Pex Ends Conform to ASTM F1807
- Expansion Pex Ends Conform to ASTM F1960
- Supplies Radiators, Convectors, Baseboards & Kick Space Heaters

PART #	SIZE / DESCRIPTION	INNER	MASTER
MFPT0058	5/8" F1807 Pex	10	100
MFPS3412	3/4" F1807 Pex x 3/4" F1807 Pex x 1/2" Swt	10	100
MFPT3412	3/4" F1807 Pex x 3/4" F1807 Pex x 1/2" F1807 Pex	10	100
MFWT3412	3/4" F1960 Pex x 3/4" F1960 Pex" x 1/2" F1960 Pex	10	100

Baseboard Connector



Prevents Noise Emitting From Baseboard



Coupling x Coupling Connector

PART #	SIZE	DESCRIPTION	INNER	MASTER
R1644	3/4" x 6"	Baseboard Connector	1	24

Tubing x Tubing Connector

PART #	SIZE	DESCRIPTION	INNER	MASTER
R1641	3/4" x 18"	Baseboard Connector	1	24

Tubing x Coupling Connector

PART #	SIZE	DESCRIPTION	INNER	MASTER
R1643	3/4" x 8"	Baseboard Connector	1	12
R1640	3/4" x 18"	Baseboard Connector	1	24
R1642	3/4" x 18" AC	Baseboard Connector	1	24

Pigtails



PART #	SIZE / DESCRIPTION	INNER	MASTER
BRPS0014	1/4" Straight Pigtail Brass	10	100
BRPA0014	1/4" Angle Pigtail Brass	10	100
BLPT0014	1/4" Angle Pigtail Black Steel	10	100

HEATING SPECIALTIES

Radiator Spud Wrench



The Radiator Spud Wrench goes inside of the pipe to easily remove and replace an old radiator valve.

Radiator Spud Wrench



Inner Pipe Wrench • For Radiator Valve Repairs



- Use to Remove and Install Radiator Valve Spuds from Radiator
- Made of Durable Cast Malleable Iron
- Insert in Radiator Nipple Until Proper Size Reached

PART #	SIZE	DESCRIPTION	INNER	MASTER
402443	1-1/2" x 2" x 10-1/4"	Spud Wrench	10	60

3 in 1 Radiator Repair Tool



HVAC Tool • For Radiator Air Valve Repairs



- Black Steel
- Extracts, Re-taps, and Rethreads Broken Valves in Radiators
- Steel Construction

PART #	SIZE	DESCRIPTION	INNER	MASTER
48612	3/4" x 3" x 2-3/4"	Radiator Repair Tool	10	60

Radiator Handle Replacement Kit



Molded Thermal Plastic Handle

- Molded Embossed Direction Arrow
- Designed to Work with a Hot-Water or Steam Valve
- 3-Step Metal insert
- Fits All Popular Stems



PART #	SIZE	DESCRIPTION	INNER	MASTER
48403	Fits All	Plastic Radiator Handle	12	144

Radiator Handle Replacement



Molded Thermal Plastic Handle

- Molded Embossed Direction Arrow
- Designed to Work with a Hot-Water or Steam Valve
- Fits All Popular Stems



PART #	SIZE	DESCRIPTION	INNER	MASTER
4800	Fits All	Plastic Radiator Handle	12	144

RADIATOR AIR VALVES

Radiator Air Valve



- Chrome Plated Steam Air Vents
- Max Pressure - 10 PSI



PART #	SIZE	DESCRIPTION	INNER	MASTER
49182	1/8"	Angle Steam Air Vent	12	144
49183	1/8"	Angle Adjustable Steam Air Vent	12	144
49181	1/8"	Straight Steam Air Vent	12	144
49141	1/4"	Straight Steam Air Vent	12	144
49341	3/4"	Straight Steam Air Vent	12	144

Radiator Air Valve Gorton Style



- Max Operating Pressure - 5 PSI
- Max Pressure - 10 PSI



PART #	SIZE	DESCRIPTION	INNER	MASTER
GAV-4A18	1/8"	Angle Steam Air Vent	12	144
GAV-5A18	1/8"	Angle Steam Air Vent	12	144
GAV-6A18	1/8"	Angle Steam Air Vent	12	144
GAV-CA18	1/8"	Angle Steam Air Vent	12	144
GAV-DA18	1/8"	Angle Steam Air Vent	12	144
GAV-6S18	1/8"	Straight Steam Air Vent	12	144
GAV-CS18	1/8"	Straight Steam Air Vent	12	144
GAV-DS18	1/8"	Straight Steam Air Vent	12	144

Radiator Air Valve



- Max Operating Pressure - 5 PSI
- Max Pressure - 10 PSI



PART #	SIZE	DESCRIPTION	INNER	MASTER
HAV-A0018	1/8"	Angle Steam Air Vent	12	144
HAV-S0018	1/8"	Straight Steam Air Vent	12	144
HAV-S0014	1/4"	Straight Steam Air Vent	12	144
HAV-S3412	3/4" X 1/2"	Straight Steam Air Vent	12	144

Automatic Air Valve w/ Plastic Knob



PART #	SIZE	DESCRIPTION	INNER	MASTER
48500	1/8"	Male Threaded	10	100

Automatic Air Valve w/ Slot Knob



PART #	SIZE	DESCRIPTION	INNER	MASTER
48503	1/8"	Male Threaded	10	100

Radiator Air Valve Hoffman Style



- Float-Type Vent
- Highly Durable



PART #	SIZE	DESCRIPTION	INNER	MASTER
RAVHA18	1/8"	Angle Steam Air Vent	12	144
RAVHA18A	1/8"	Angle Adjustable Steam Air Vent	12	144
RAVHS18	1/8"	Straight Steam Air Vent	12	144
RAVHS14	1/4"	Straight Steam Air Vent	12	144
RAVHS3412	3/4" X 1/2"	Straight Steam Air Vent	12	144

Radiator Air Valve Gorton Style



- Steam Air Vent



PART #	SIZE	DESCRIPTION	INNER	MASTER
RAVG18-4	#4 1/8"	Angle Steam Air Vent	10	60
RAVG18-5	#5 1/8"	Angle Steam Air Vent	8	48
RAVG18-6	#6 1/8"	Angle Steam Air Vent	6	36
RAVG18-D	#C 1/8"	Angle Steam Air Vent	10	60
RSVG18-6	#D 1/8"	Angle Steam Air Vent	10	60
RSVG18-6	#6 1/8"	Straight Steam Air Vent	6	36
RSVG18-C	#C 1/8"	Straight Steam Air Vent	10	60
RSVG18-D	#D 1/8"	Straight Steam Air Vent	10	60

Float Vents



- Perfect for Tight spaces
- 50 PSI
- For Use on Convector Radiators, Radiant Baseboard & Radiant Panels



PART #	SIZE	DESCRIPTION	INNER	MASTER
LF-FV18	1/8"	Float Vent	10	50

Coin Key Air Valve



PART #	SIZE	DESCRIPTION	INNER	MASTER
48400	1/8"	Male Threaded	10	100

Key For Coin Air Valve



PART #	SIZE	DESCRIPTION	INNER	MASTER
48401	1/8"	Key for Part # 48400	10	100

HEATING SPECIALTIES

Ductile Iron Circulator Flange Kit

RAVEN
SPECIALTY PRODUCTS



- For Taco/Grundfos
- All Circulator Flanges are Packaged with Nuts & Bolts
- New High Grip Surface
- Ideal for Use with Pipe Wrench

GREEN PART #	RED PART #	SIZE	DESCRIPTION	INNER	MASTER
DIFLNG34G	DIFLNG34R	3/4"	Flange Kit	25	100
DIFLNG1G	DIFLNG1R	1"	Flange Kit	12	12
DIFLNG114G	DIFLNG114R	1-1/4"	Flange Kit	12	12
DIFLNG112G	DIFLNG112R	1-1/2"	Flange Kit	12	12

Brass Circulator Flange Kit

RAVEN
SPECIALTY PRODUCTS

Lead Free



- Sold in Pairs
- KIT Includes: 2 Flanges, 2 Neoprene Gaskets & 4 Nuts & Bolts



SWT PART #	IPS PART #	SIZE	DESCRIPTION	INNER	MASTER
CFSWT34-NL	CFIPS34-NL	3/4"	Flange Kit	25	100
CFSWT1-NL	CFIPS1-NL	1"	Flange Kit	12	12
CFSWT114-NL	CFIPS114-NL	1-1/4"	Flange Kit	12	12
CFSWT112-NL		1-1/2"	Flange Kit	12	12

Flange Gaskets

PART #	SIZE	DESCRIPTION	INNER	MASTER
CFGASKET	3/4"	1 Set of Flange Gaskets	10	1000

Nuts & Bolts For Circulator Flange

PART #	SIZE	DESCRIPTION	INNER	MASTER
CFNUTS	Xx"	1 Set of Nuts and Bolts	1	45

Heavy Duty Oil Tank Legs

RAVEN
SPECIALTY PRODUCTS

Used to Support Oil Tank



PART #	SIZE	DESCRIPTION	INNER	MASTER
TANKLEGS10	1-1/4" X 10"	Union Elbow	1	24
TANKLEGS12	1-1/4" X 12"	Union Elbow	1	24
TANKLEGS13	1-1/4" X 13"	Union Elbow	1	24
TANKLEGS14	1-1/4" X 14"	Union Elbow	1	24

Heavy Duty Oil Tank Elbow

RAVEN
SPECIALTY PRODUCTS

Used to Connect Isolation Valve



- Heavy Duty Sch 40 Steel Elbow
- Will Not Break with Pressure from Ice or if Stepped On
- Extends 2" Past the Outside of Tank for Easy Connection
- Inline Fusible Oil Valve Can be Placed After Isolation Valve

PART #	SIZE	DESCRIPTION	INNER	MASTER
OTL1238	3/8" X 1/2"	2" x 6" Tank Elbow	12	60

Oil Vent Cap & Screen

RAVEN
SPECIALTY PRODUCTS

Zinc Plated Galvanized Steel



- Use On Oil Tank Vent Pipes
- Lightweight Design
- Includes Screen to Prevent Debris from Entering Vent Pipe
- Zinc Plated Galvanized Steel to Prevent Rust

Vent Cap w/ Screen

PART #	SIZE	DESCRIPTION	INNER	MASTER
VCS114	1-1/4"	Oil Tank Vent Cap w/ Screen	1	100
VCS112	1-1/2"	Oil Tank Vent Cap w/ Screen	1	100
VCS2	2"	Oil Tank Vent Cap w/ Screen	1	50

Vent Cap

PART #	SIZE	DESCRIPTION	INNER	MASTER
VC114	1-1/4"	Oil Tank Vent Cap	1	100

 **EVERFLOW™**

 **PEXFLOW™**
PRO SERIES

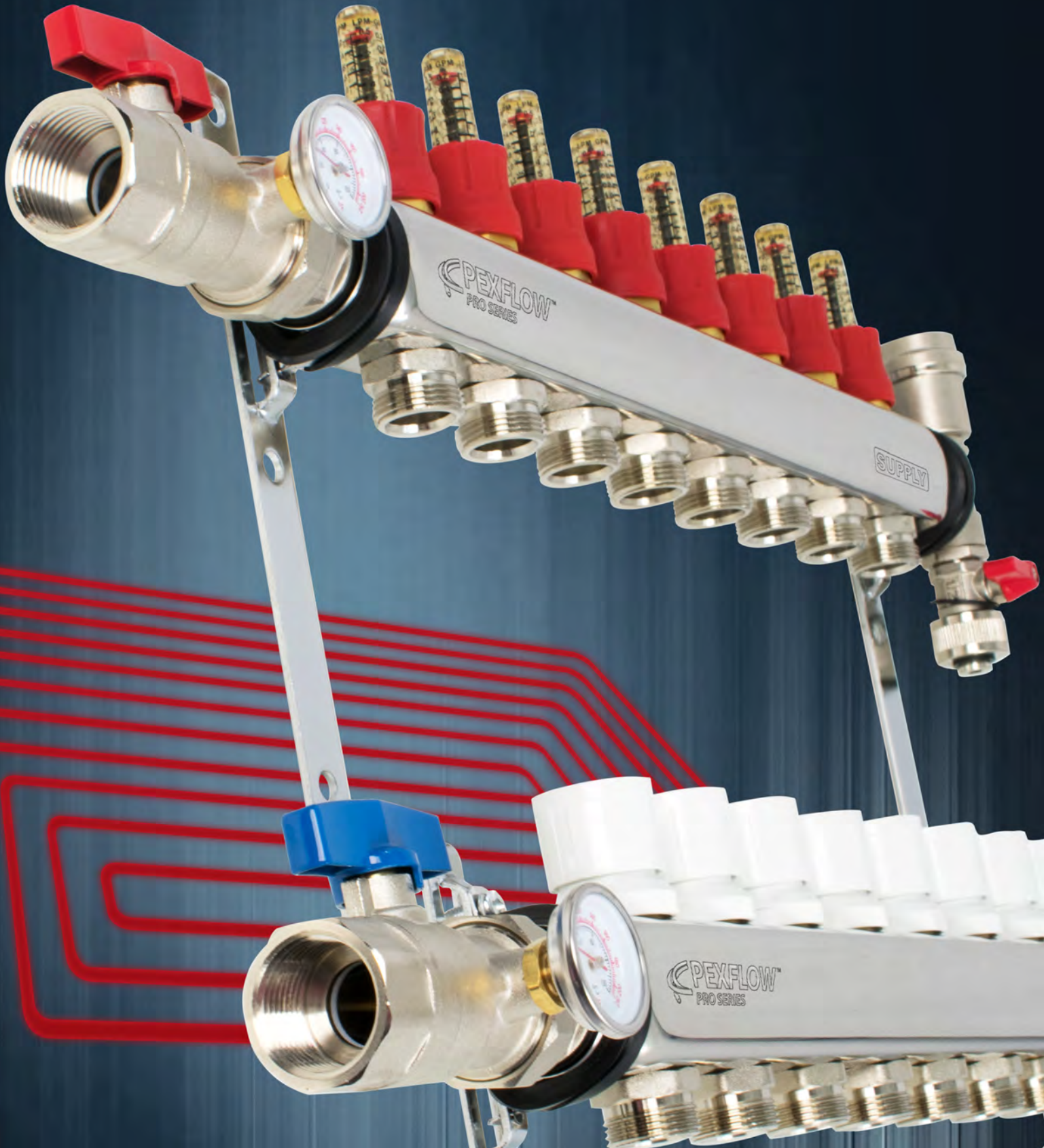

PEX MANIFOLDS & ACCESSORIES

Pexflow Pro Series Radiant Heat Manifolds



Stainless Steel All-In-One Pre-Assembled Manifold Sets For Radiant Heating

- Includes: Balancing Valves, Air Vent, Fill/Drain Valves, Shut-Off Valves w/ Temp Gauges & Brackets
- Pressure Tested. Maximum Flow Per Branch is 1.4 GPM. Max Operating Temperature is 158°F
- Packaged with 1/2" PEX Adapters. Other Size Options Available
- Stainless Steel Supply & Return Manifolds with Flow Meters
- Pre-Assembled with Valves & Mounting Brackets
- Available from 2 Branch to 12 Branch



PART #	DESCRIPTION	INNER	MASTER
MPS102	2-Branch Pex Manifold	1	4
MPS103	3-Branch Pex Manifold	1	4
MPS104	4-Branch Pex Manifold	1	4
MPS105	5-Branch Pex Manifold	1	4
MPS106	6-Branch Pex Manifold	1	4
MPS107	7-Branch Pex Manifold	1	4
MPS108	8-Branch Pex Manifold	1	2
MPS109	9-Branch Pex Manifold	1	2
MPS110	10-Branch Pex Manifold	1	2
MPS112	12-Branch Pex Manifold	1	2

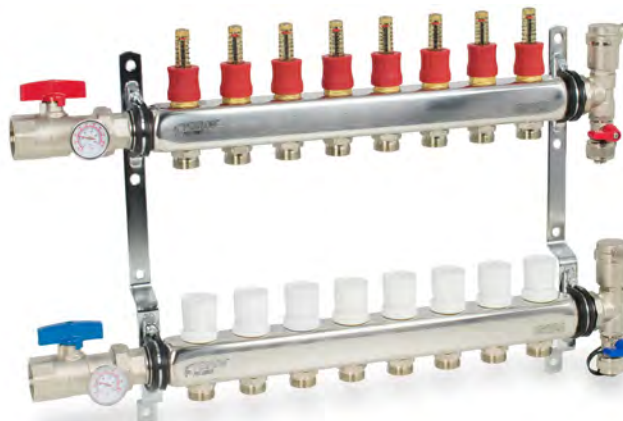

Thermostatic Acuator Valve



For Pex Manifolds • 24 V • 2 Wire and 4 Wire



PART #	DESCRIPTION	INNER	MASTER
MPA200	24V 2 Wire Thermostatic Actuator for Pex	1	50
MPA400	24V 4 Wire Thermostatic Actuator for Pex	1	50

Pex Manifold Ball Valve



With Temperature Gauge



BLUE PART #	RED PART #	DESCRIPTION	INNER	MASTER
MPV-SB	MPV-SR	Manifold Ball Valve w/ Gauge	1	15
MPV-AB	MPV-AR	Angle Manifold Ball Valve w/ Gauge	1	15

Pex Manifold Adapter



Nickel



F1807 PART #	F1960 PART #	DESCRIPTION	INNER	MASTER
MPX012	MPW012	1/2" Pex X 3/4" Manifold Adapter	42	336
MPX038	MPW038	3/8" Pex X 3/4" Manifold Adapter	42	336
MPX058	MPW058	5/8" Pex X 3/4" Manifold Adapter	42	336
MPX034		3/4" Pex X 3/4" Manifold Adapter	42	336

Manifold Cap



Seal Off Unused Manifold Circuits



PART #	DESCRIPTION	INNER	MASTER
MPC034	Manifold Cap	1	320

Pex Manifold Air Vent Drain Valve



Nickel End Piece



PART #	DESCRIPTION	INNER	MASTER
MPE200	Pex Manifold Air Vent & Drain Valve	1	15
MPE100	Pex Manifold Drain Valve End Piece	1	15

Manifold Flowmeter Replacement



For Radiant Heat Manifolds



PART #	DESCRIPTION	INNER	MASTER
MPF-FM	Manifold Flowmeter Replacement	20	100

STEEL MANIFOLDS

RAVEN
 SPECIALTY PRODUCTS

The Original EZ Header Steel Manifolds

Schedule 40 Pipe Meets ASTM A53 Standard • Threaded Ends Comply With ANSI/ASME B 1.20.1

- Angular Deviation Between Main Pipe & Branch pipe is 30°
- Used in a Boiler Room to Act as a Hub for Heating System
- Threaded Ends Comply with ANSI/ASME B 1.20.1
- Pipe Meets Standard ASTM A53 Sch.40
- Free of Burrs and Fins



Product shipped with thread protectors on all ends

2 Zone

PART #	SPACE	MAIN DIAMETER	BRANCH DIAMETER	INNER	MASTER
SH2-1034-6	6"	1"	3/4"	1	6
SH2-1034-7	7"	1"	3/4"	1	6
SH2-1434-6	6"	1-1/4"	3/4"	1	6
SH2-1434-7	7"	1-1/4"	3/4"	1	6
SH2-1410-6	6"	1-1/4"	1"	1	6
SH2-1410-7	7"	1-1/4"	1"	1	6
SH2-1534-7	7"	1-1/2"	3/4"	1	6
SH2-1510-6	6"	1-1/2"	1"	1	6
SH2-1510-7	7"	1-1/2"	1"	1	6

3 Zone

PART #	SPACE	MAIN DIAMETER	BRANCH DIAMETER	INNER	MASTER
SH3-1034-6	6"	1"	3/4"	1	6
SH3-1034-7	7"	1"	3/4"	1	6
SH3-1434-6	6"	1-1/4"	3/4"	1	6
SH3-1434-7	7"	1-1/4"	3/4"	1	6
SH3-1410-6	6"	1-1/4"	1"	1	6
SH3-1410-7	7"	1-1/4"	1"	1	6
SH3-1421-6	6"	1-1/4"	3/4" & one 1"	1	6
SH3-1421-7	7"	1-1/4"	3/4" & one 1"	1	6
SH3-1534-6	6"	1-1/2"	3/4"	1	6
SH3-1534-7	7"	1-1/2"	3/4"	1	6
SH3-1510-6	6"	1-1/2"	1"	1	6
SH3-1510-7	7"	1-1/2"	1"	1	6

4 Zone

PART #	SPACE	MAIN DIAMETER	BRANCH DIAMETER	INNER	MASTER
SH4-1034-6	6"	1"	3/4"	1	6
SH4-1034-7	7"	1"	3/4"	1	6
SH4-1434-6	6"	1-1/4"	3/4"	1	6
SH4-1434-7	7"	1-1/4"	3/4"	1	6

4 Zone continued

PART #	SPACE	MAIN DIAMETER	BRANCH DIAMETER	INNER	MASTER
SH4-1431-6	6"	1-1/4"	3/4" & one 1"	1	6
SH4-1431-7	7"	1-1/4"	3/4" & one 1"	1	6
SH4-1410-6	6"	1-1/4"	1"	1	6
SH4-1410-7	7"	1-1/4"	1"	1	6
SH4-1534-6	6"	1-1/2"	3/4"	1	6
SH4-1534-7	7"	1-1/2"	3/4"	1	6
SH4-1510-6	6"	1-1/2"	1"	1	6
SH4-1510-7	7"	1-1/2"	1"	1	6
SH4-2010-7	7"	2"	1"	1	6
SH4-2014-7	7"	2"	1-1/4"	1	6

5 Zone

PART #	SPACE	MAIN DIAMETER	BRANCH DIAMETER	INNER	MASTER
SH5-1434-6	6"	1-1/4"	3/4"	1	6
SH5-1434-7	7"	1-1/4"	3/4"	1	6
SH5-1431-7	7"	1-1/4"	3/4" & one 1"	1	6
SH5-1534-7	7"	1-1/2"	3/4"	1	6
SH5-1510-6	6"	1-1/2"	1"	1	6
SH5-1510-7	7"	1-1/2"	1"	1	6

6 Zone

PART #	SPACE	MAIN DIAMETER	BRANCH DIAMETER	INNER	MASTER
SH6-1434-7	7"	1-1/4"	3/4"	1	6
SH6-1410-6	6"	1-1/4"	1"	1	6
SH6-1410-7	7"	1-1/4"	1"	1	6
SH6-1534-7	7"	1-1/2"	3/4"	1	6
SH6-1510-6	6"	1-1/2"	1"	1	6
SH6-1510-7	7"	1-1/2"	1"	1	6
SH6-2014-7	7"	2"	1-1/4"	1	6

7 Zone

PART #	SPACE	MAIN DIAMETER	BRANCH DIAMETER	INNER	MASTER
SH7-2010-7	7"	2"	1"	1	6

COPPER MANIFOLDS

RAVEN
 SPECIALTY PRODUCTS

Copper Manifolds

- Applications: Zone Manifolds, Radiant Manifolds
Return Manifolds and Boiler Headers
- Packaged with Metal Sheet to Prevent Damage During Shipping
- Standard SWT Ends
- Individually Boxed for Easy Shipping



24 Copper Branch Manifold Type K

- 3" Center
- 72" Long

PART #	SIZE	INNER	MASTER
CM-1C2412-K	1" x 1/2"	1	1
CM-1C2434-K	1" x 3/4"	1	1
CM-114C2412-K	1-1/4" x 1/2"	1	1
CM-114C2434-K	1-1/4" x 3/4"	1	1

18 Copper Branch Manifold Type L

- 4" Center
- 72" Long

PART #	SIZE	INNER	MASTER
CM-1C1812	1" x 1/2"	1	1
CM-1C1834	1" x 3/4"	1	1
CM-114C1812	1-1/4" x 1/2"	1	1
CM-114C1834	1-1/4" x 3/4"	1	1
CM-112C1834	1-1/2" x 3/4"	1	1
CM-2C1834	2" x 3/4"	1	1

12 Copper Branch Manifold Type L

- 6" Center
- 72" Long

PART #	SIZE	INNER	MASTER
CM-1C1212	1" x 1/2"	1	1
CM-1C1234	1" x 3/4"	1	1
CM-114C1212	1-1/4" x 1/2"	1	1
CM-114C1234	1-1/4" x 3/4"	1	1
CM-114C121	1-1/4" x 1"	1	1
CM-112C1234	1-1/2" x 3/4"	1	1
CM-112C121	1-1/2" x 1"	1	1
CM-2C1234	2" x 3/4"	1	1
CM-2C121	2" x 1"	1	1

6 Copper Branch Manifold Type L

- 4" Center
- 24" Long

PART #	SIZE	INNER	MASTER
CM-1C612	1" x 1/2"	1	1
CM-114C634	1-1/4" x 3/4"	1	1

5 Copper Branch Manifold Type L

- 4" Center
- 20" Long

PART #	SIZE	INNER	MASTER
CM-114C534	1-1/4" x 3/4"	1	1

4 Copper Branch Manifold Type L

- 4" Center
- 20" Long

PART #	SIZE	INNER	MASTER
CM-114C434	1-1/4" x 3/4"	1	1

3 Copper Branch Manifold Type L

- 6" Center
- 18" Long

PART #	SIZE	INNER	MASTER
CM-1C3346	1" x 3/4"	1	1
CM-114C3346	1-1/4" x 3/4"	1	1

3 Copper Branch Manifold Type L

- 4" Center
- 12" Long

PART #	SIZE	INNER	MASTER
CM-1C334	1" x 3/4"	1	1
CM-114C334	1-1/4" x 3/4"	1	1

Safety Signs

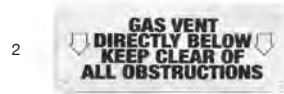
RAVEN
 SPECIALTY PRODUCTS

GAS VENT DIRECTLY BELOW KEEP CLEAR OF ALL OBSTRUCTIONS

PART #	MATERIAL	COLOR	SIZE
SIGN#1	Rigid Plastic	Yellow	3" x 7"
SIGN#2	Rigid Plastic	Clear	3" x 7"

EXHAUST

PART #	MATERIAL	COLOR	SIZE
SIGN#3	Pressure Sensitive Vinyl - Adhesive Backed	Yellow	3" x11-1/2"

AIR INTAKE

PART #	MATERIAL	COLOR	SIZE
SIGN#4	Pressure Sensitive Vinyl - Adhesive Backed	Yellow	3" x11-1/2"

SPRINKLERS THROUGHOUT BUILDING

PART #	MATERIAL	COLOR	SIZE
SIGN#5	Rigid Plastic	White	7" x 9"

THIS VALVE CONTROLS AUTOMATIC SPRINKLER SYSTEM AND MUST ALWAYS BE KEPT OPEN

PART #	MATERIAL	COLOR	SIZE
SIGN#6	Rigid Plastic	Red	7" x 9"

AUTOMATIC SPRINKLER SHUT OFF VALVE LOCATED ___ FT. OPPOSITE THIS SIGN

PART #	MATERIAL	COLOR	SIZE
SIGN#7	Rigid Plastic	White	7" x 9"

FIRE ALARM WHEN BELL RINGS CALL FIRE DEPT OR 911 _____

PART #	MATERIAL	COLOR	SIZE
SIGN#8	Rigid Plastic	Red	7" x 9"

FIRE ALARM WHEN BELL RINGS CALL FIRE DEPT OR 911

PART #	MATERIAL	COLOR	SIZE
SIGN#9	Rigid Plastic	White	7" x 9"

INSPECTORS TEST

PART #	MATERIAL	COLOR	SIZE
SIGN#10	Rigid Plastic	White	2" x 7"

MAIN DRAIN

PART #	MATERIAL	COLOR	SIZE
SIGN#11	Rigid Plastic	White	2" x 7"

The Complete Package.



everflowsupplies.com | 908.436.1100



Sales & Support

Everflow Supplies Inc.

Carteret NJ 07008

T: 908.436.1100

F: 908.436.1162

sales@everflowsupplies.com

Distribution

Eastern Region

100 Middlesex Ave.

Carteret NJ 07008

Midwest Region

150 S. Fairbank St.

Addison, Illinois 60101

South Central & Western Region

2300 E. Bardin Rd.

Arlington, Texas 76018

www.everflowsupplies.com

